

# ***Development of Low-Cost Alloy Supported SOFCs***

Steve Visco, Craig Jacobson, Lutgard C. De Jonghe

Materials Sciences Division  
Lawrence Berkeley National Laboratory  
1 Cyclotron Road, Berkeley, CA 94720

[sjvisco@lbl.gov](mailto:sjvisco@lbl.gov), [dejonghe@lbl.gov](mailto:dejonghe@lbl.gov), [cpjacobson@lbl.gov](mailto:cpjacobson@lbl.gov)

*Presented at SECA workshop,  
June 18, 2002, Pittsburgh, PA*



# LBNL Staffing

## Principal Investigators

Steve Visco, Lutgard De Jonghe

## Staff Scientists

Peggy Hou

Xiao-Feng Zhang

## Senior Technical Staff

Craig Jacobson

## Technical Staff

Inna Belogolovsky

## Visiting Scientist and Post Docs

Igor Villareal, Mariza Marrero-Cruz, Keiji Yamahara

FengZhang

## Graduate Students

Andy Leming, Yuriy Matus, Liming Yang, Xuan Chen

## Undergraduate Students

William Hou, Anup Goel, Kaveh Milaninia, Hoover Lee, Eric Hong,  
Scott Heise, In-Chieh Chen, MK Kim, David Blum, Johnathan Pierce



# Background: Accomplishments



# Co-fired Thin-Film Structures by Colloidal Deposition

NiO/YSZ substrate (pressed)      NiO/YSZ fired at 950 °C      NiO/YSZ substrate with green YSZ film      NiO/YSZ-YSZ bilayer fired at 1400 °C

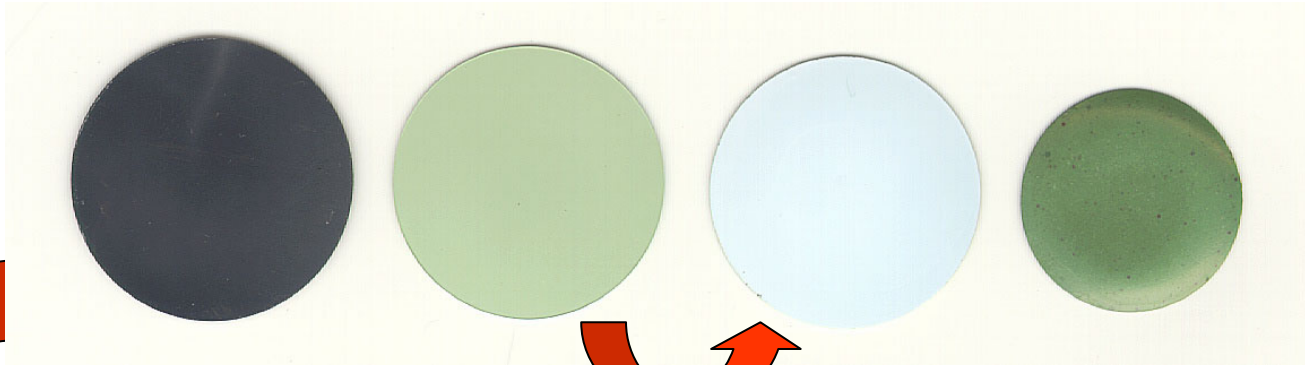

Dip-coat, aerosol spray, EPD...

- Geometry Independent
- Low Cost
- Scalable

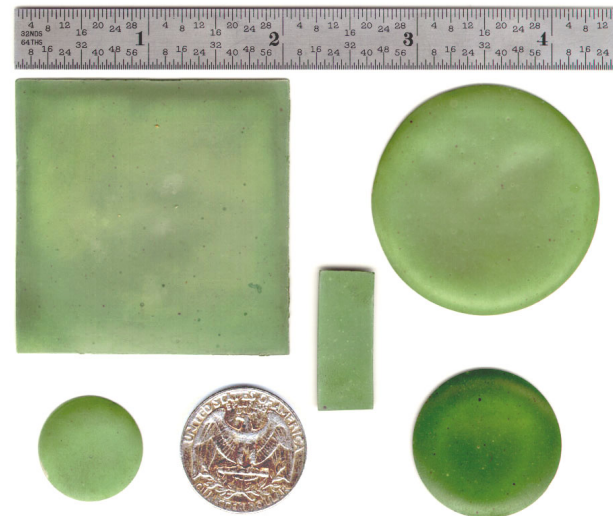

# Intermediate Temp: 750 to 850 °C; PLANAR

## Ni-YSZ/YSZ/LSM-YSZ Thin-film Cell at 800 °C

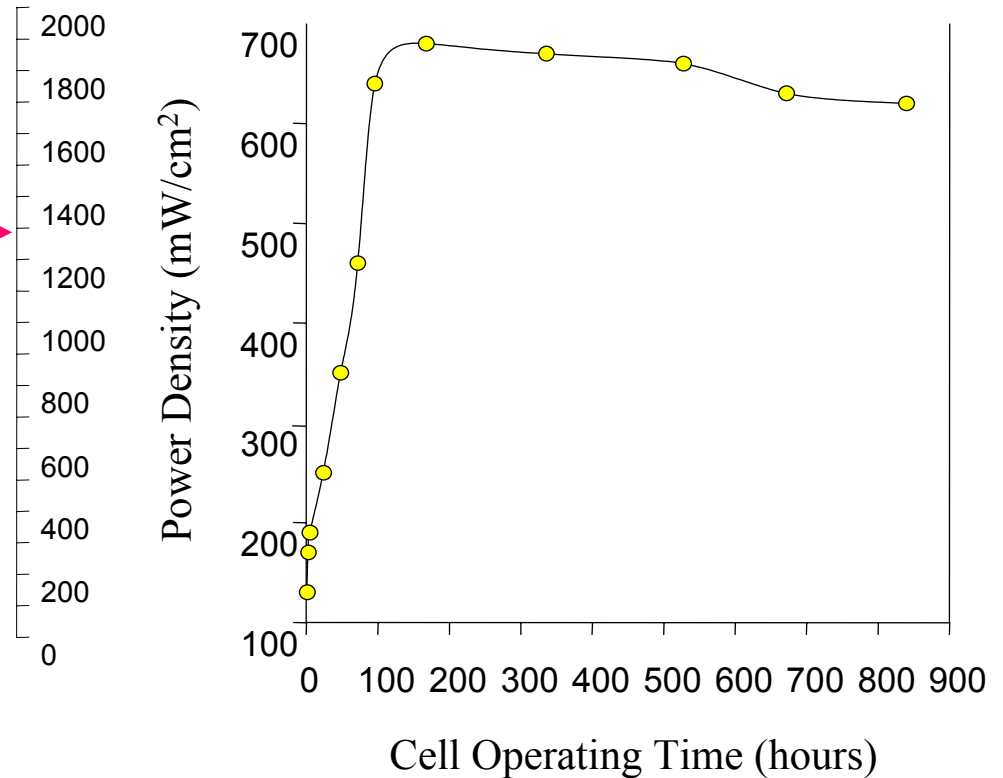
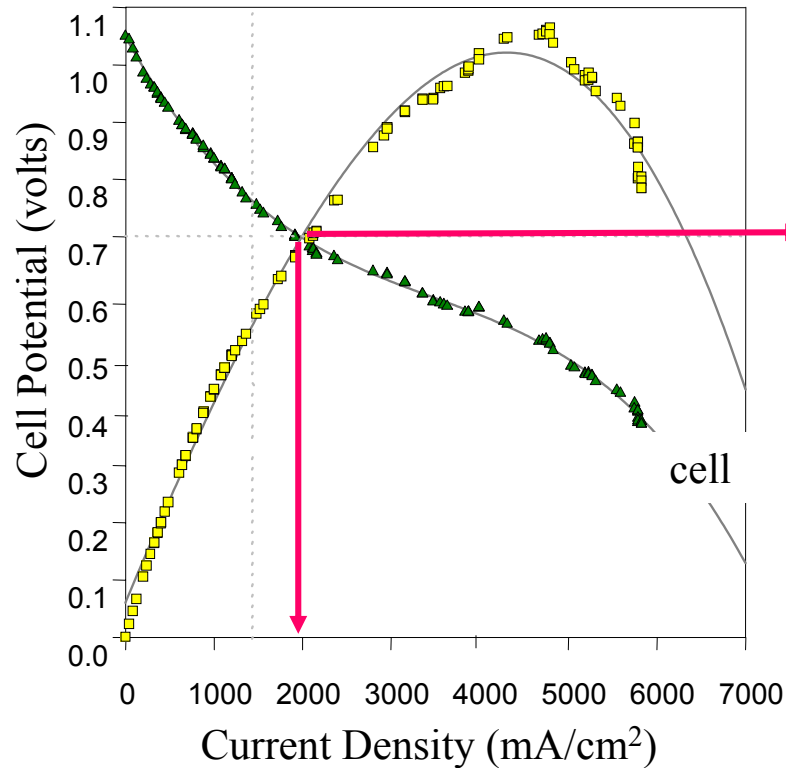

# Thin-film Ceria Cell Performance: 650 - 800 °C

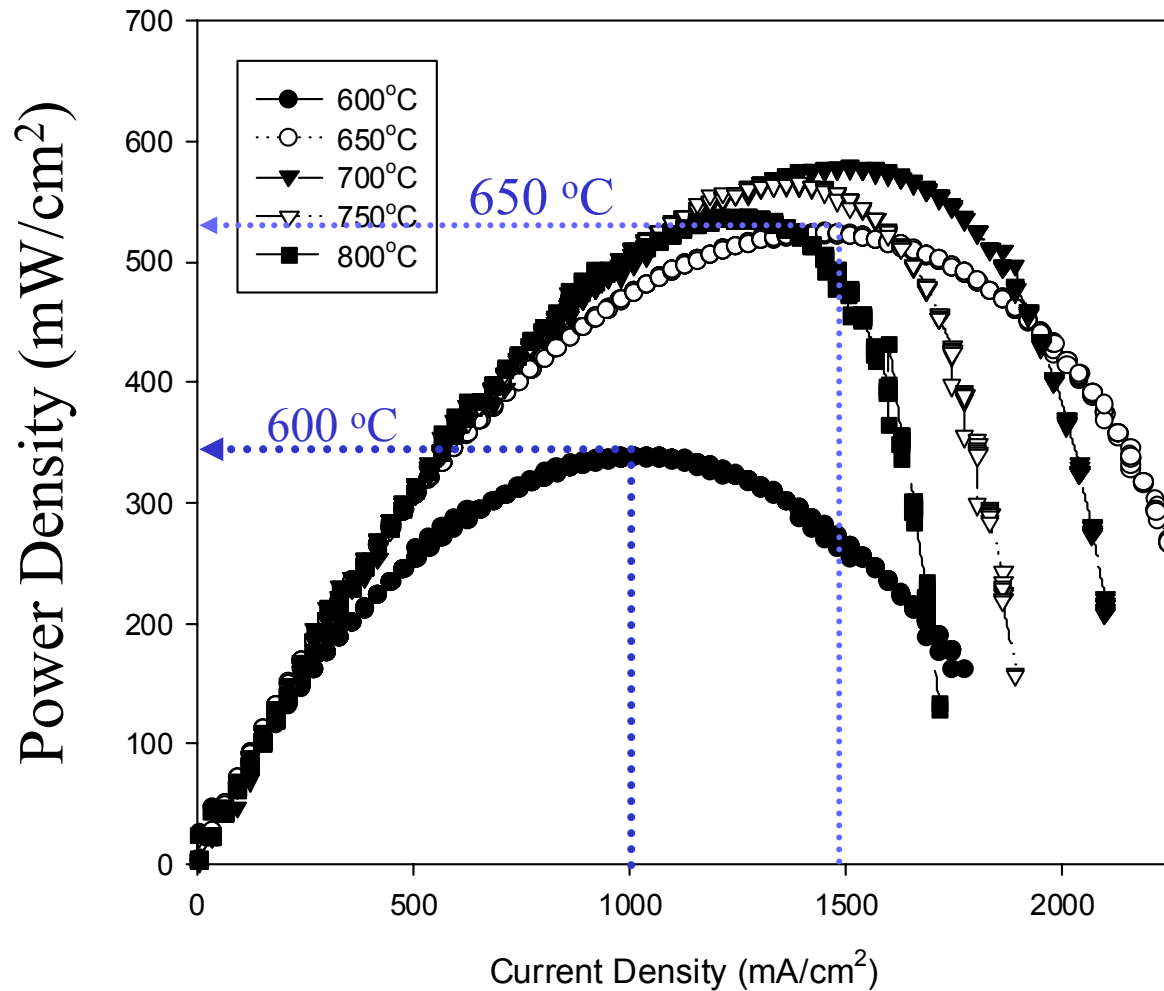

# Integrated Program Overview



# DARPA: Integrated MicroPower Generator

## Task 8: Explore Colloidal and co-firing Fabrication Routes for SCFC MEAs

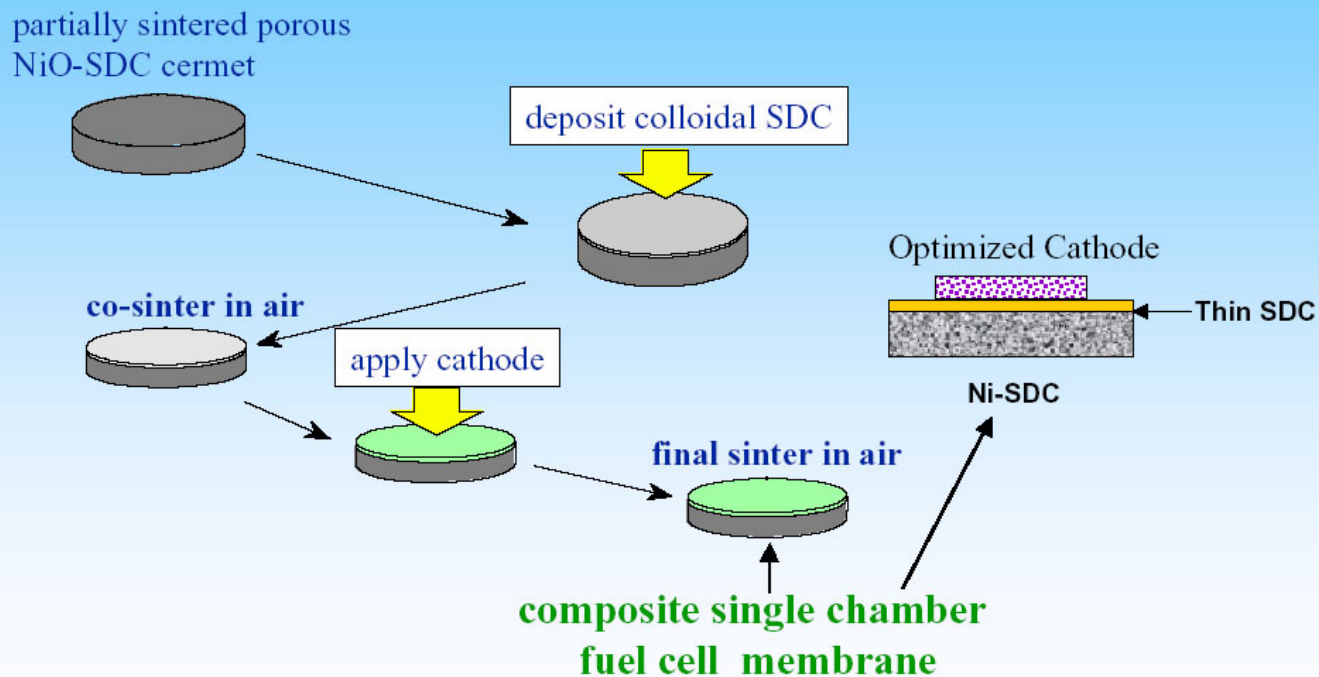

Integrated MicroPower Generator

Kick-off, Jan. 28, 2002



ERNEST ORLANDO LAWRENCE  
BERKELEY NATIONAL LABORATORY



# Praxair NIST-ATP

## Advanced Electrolytic System for Combined Oxygen Separation and Compression

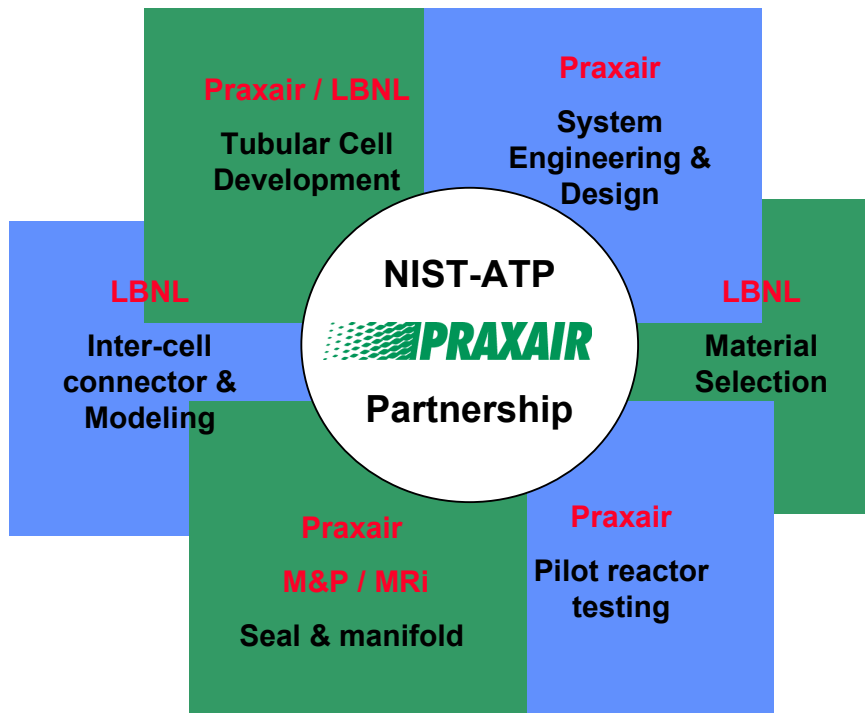

### Project Objectives

The principal project objective is to develop the technology for a new, point-of-use, oxygen generator and electrochemical compressor that will economically and efficiently replace the practice of supplying oxygen by cylinders and liquid. The end goal of the project is to demonstrate the technology in a pre-commercial, pilot-scale integrated system.



# Ikerlan: Residential Fuel Cell System

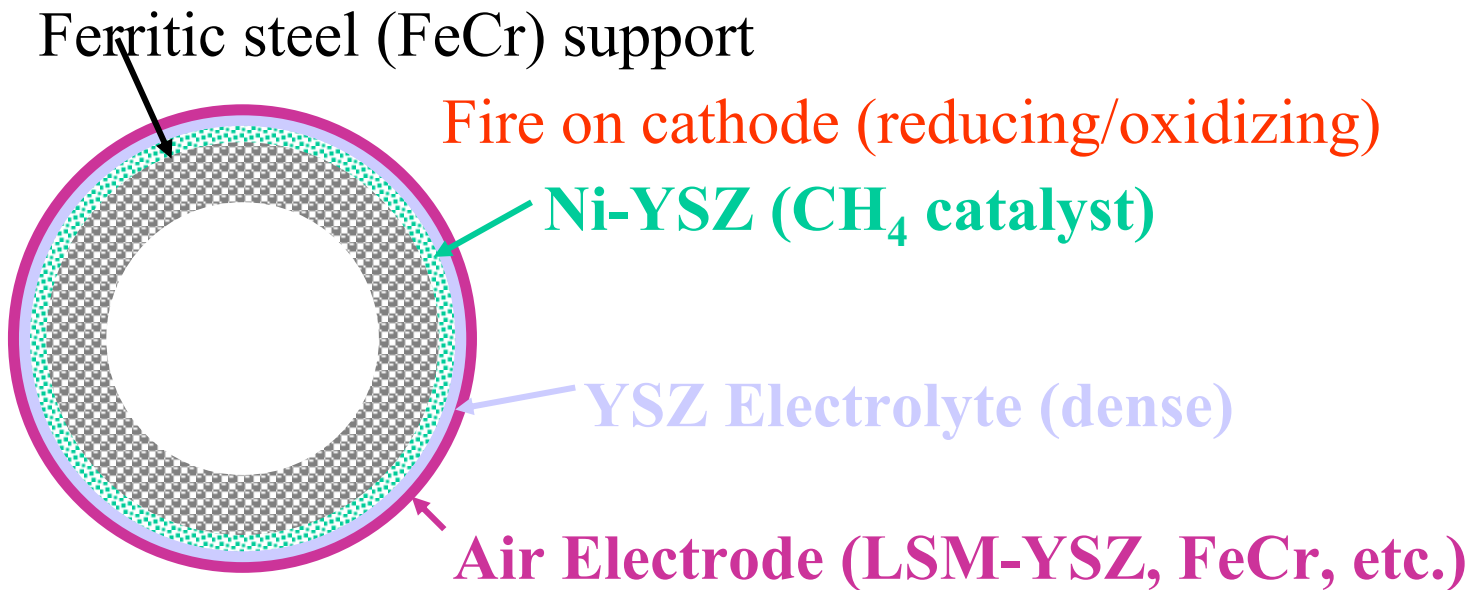

Sinter tube in reducing furnace at 1200 to 1400 °C



# NETL Program



# BASIC STACK COST/PERFORMANCE RELATIONSHIP

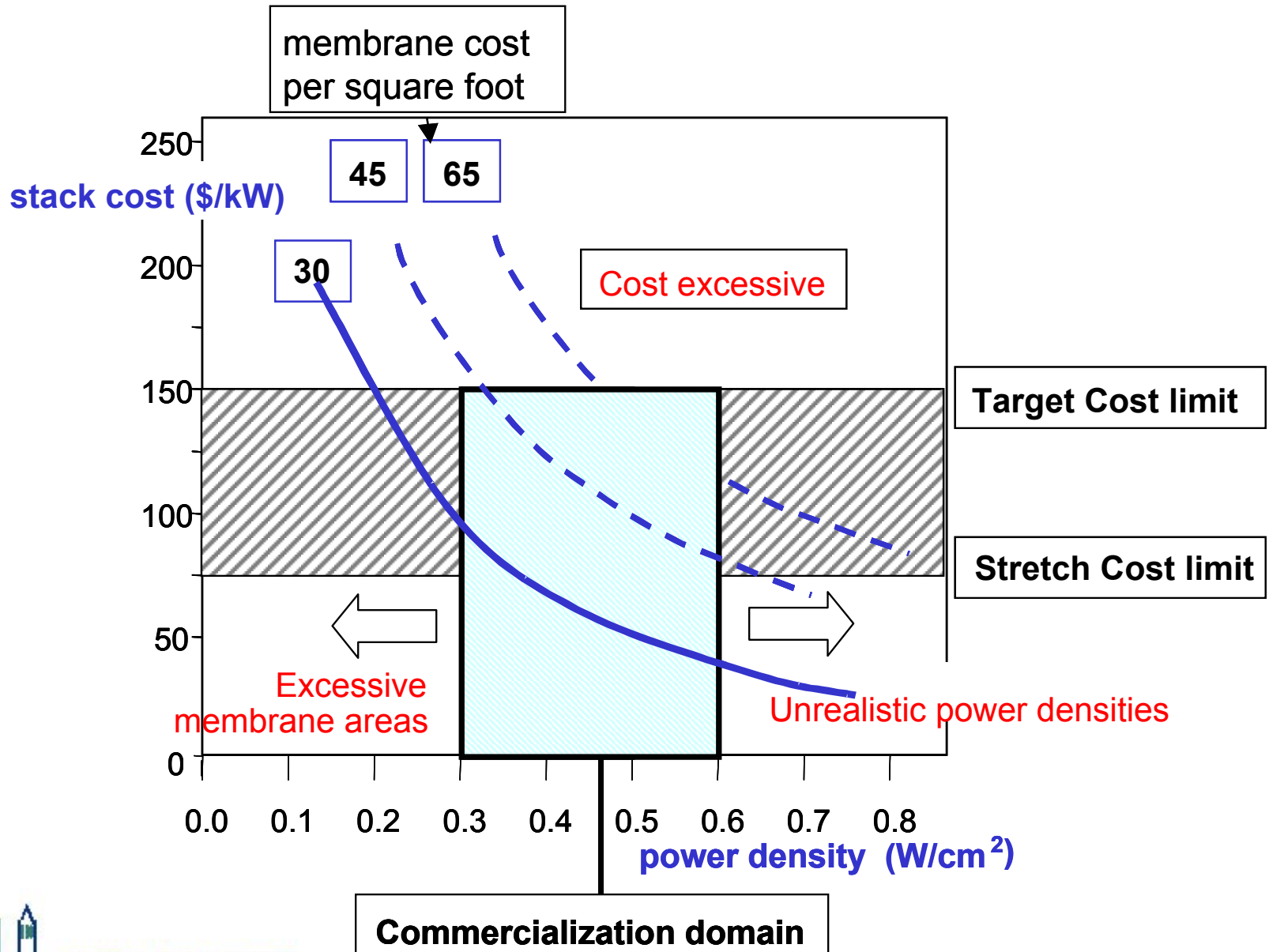

# NETL Project: Development of Inexpensive Metal Alloy Supports for Cost-Competitive Solid Oxide Fuel Cells

- The LBNL group has recently developed a novel approach to SOFC fabrication where mechanically robust and inexpensive metal alloy electrode supports are used in the construction of the SOFC stack.
- Use of porous alloy support should increase the strength and toughness of the stack as well as greatly increase the electronic and thermal conductivity, decreasing losses due to current collection and improving thermal management of the stack.
- Alloy support structures should allow novel sealing technology including welding, brazing, and even crimp seals. Seals have been one of the biggest barriers to planar SOFC technology and innovative designs are needed.
- The purpose of the initial work was to demonstrate proof of the principle and identify needed research.



# Fabrication of Low-Cost Planar SOFC

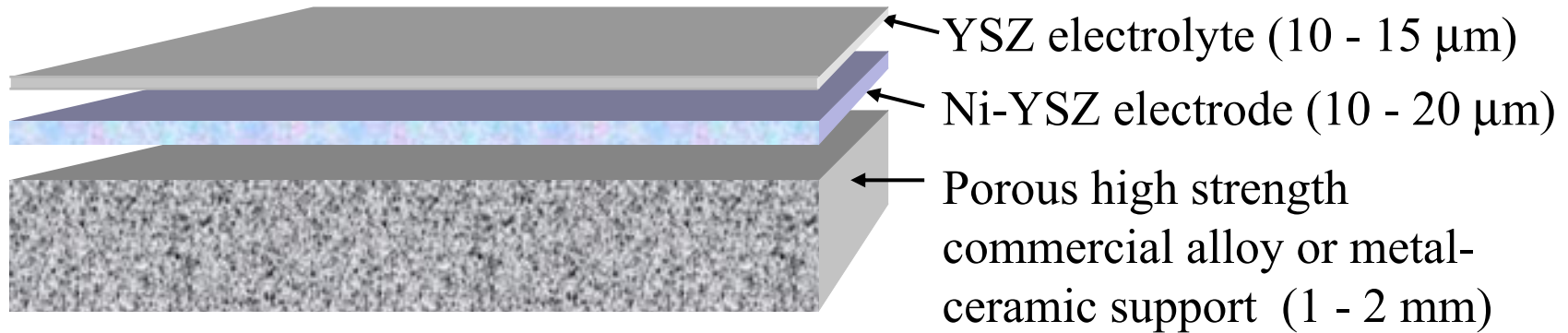

Co-fire tri-layer



Add cathode

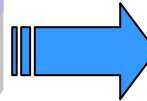

Low-cost, high performance SOFC



The anode in Ni-YSZ supported thin-film cells must be maintained in reducing environments; whereas alloy support is oxidation resistant allowing cool-down and thermal cycling in the presence of air



# Fabrication of Thin-film Metal SOFC

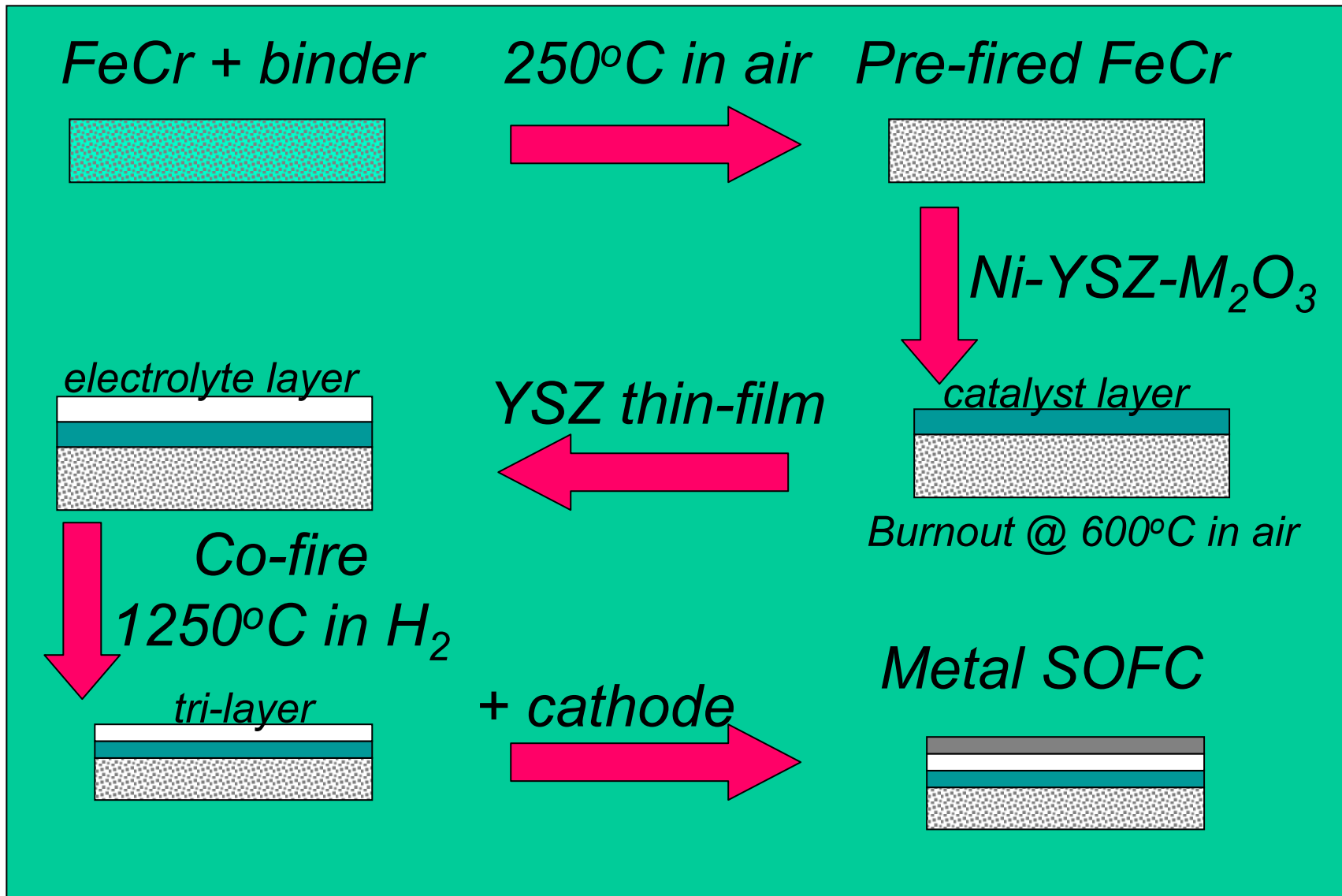

LBL Group has fabricated porous alloy supports in a variety of shapes

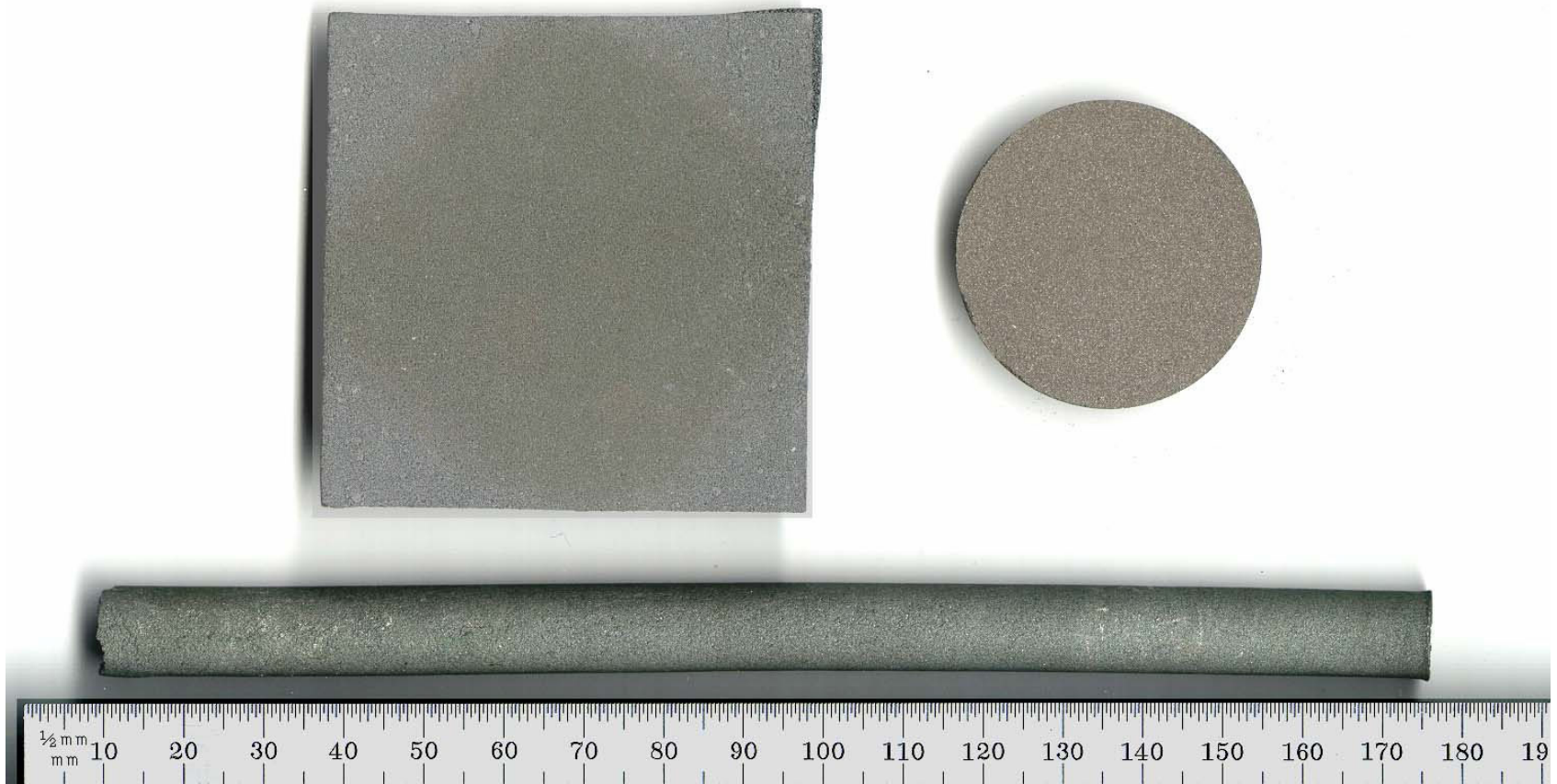



# Commercial “Pall” Tube Microstructure

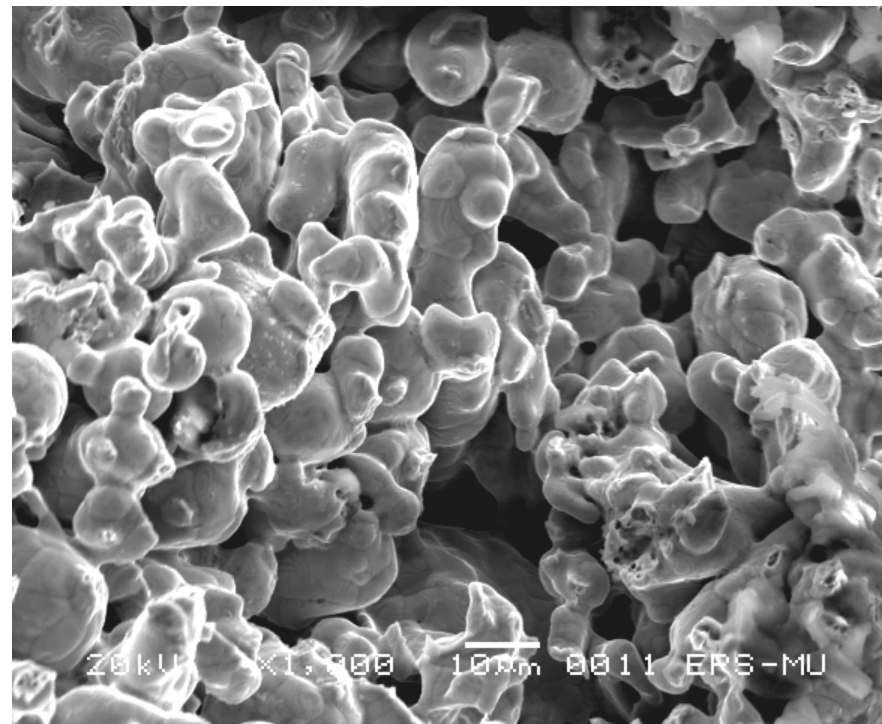
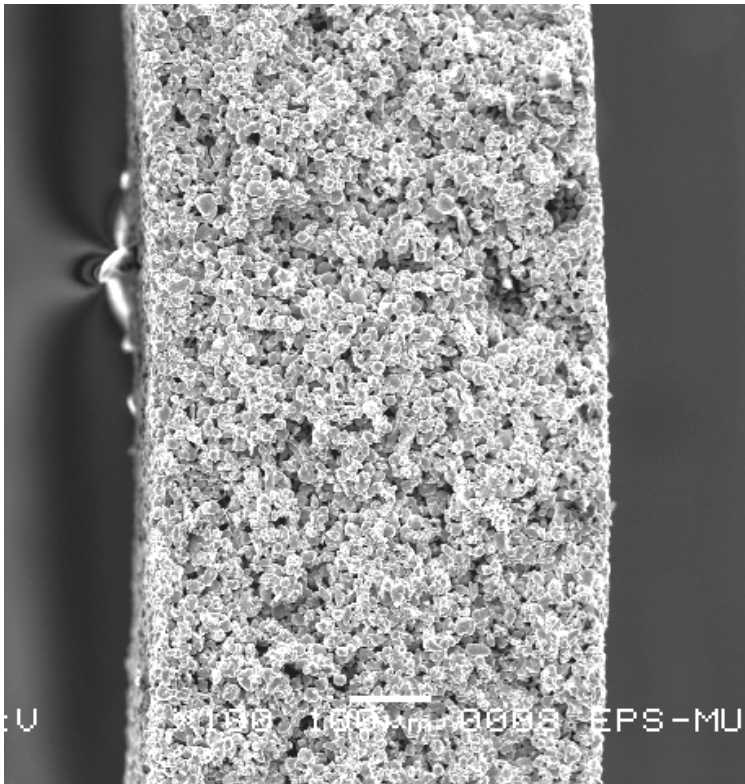

# Porous Metal Filters Available Commercially

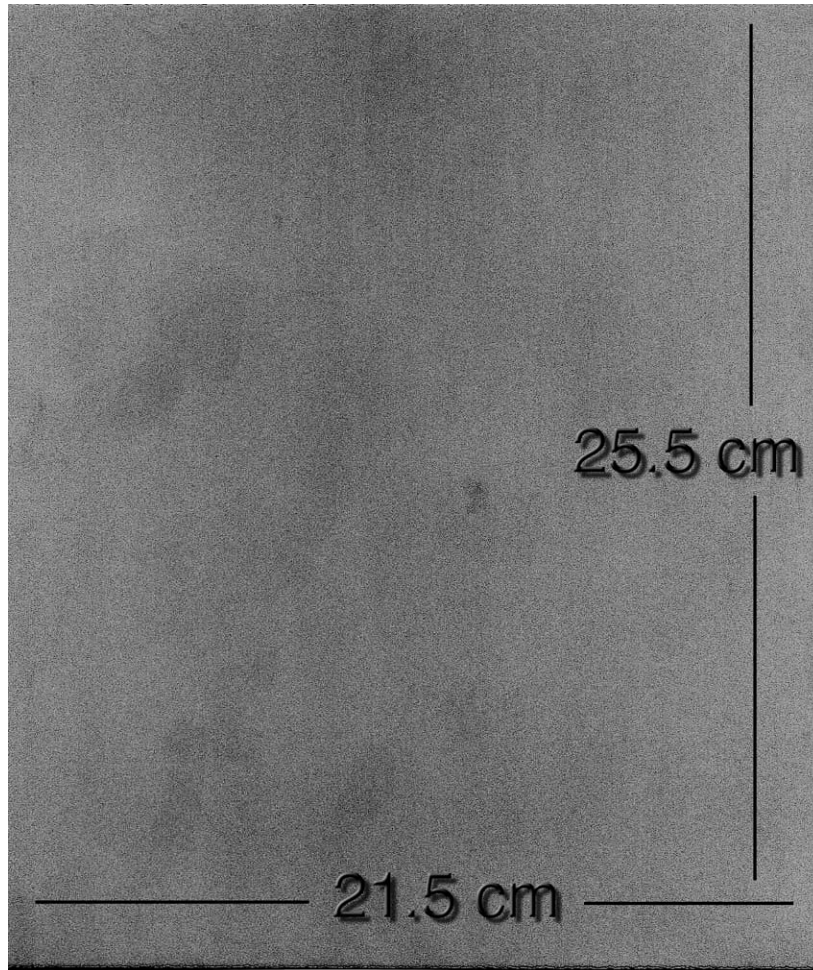

- Area = 550 cm<sup>2</sup>
- 0.5 cm seal
- 500 cm<sup>2</sup> active
- 0.3 to 0.5 W/cm<sup>2</sup> =
- 150 to 250 W/plate
- 4 to 7 plates/kW

# LBNL Welded Porous FeCr SOFC Support Tube

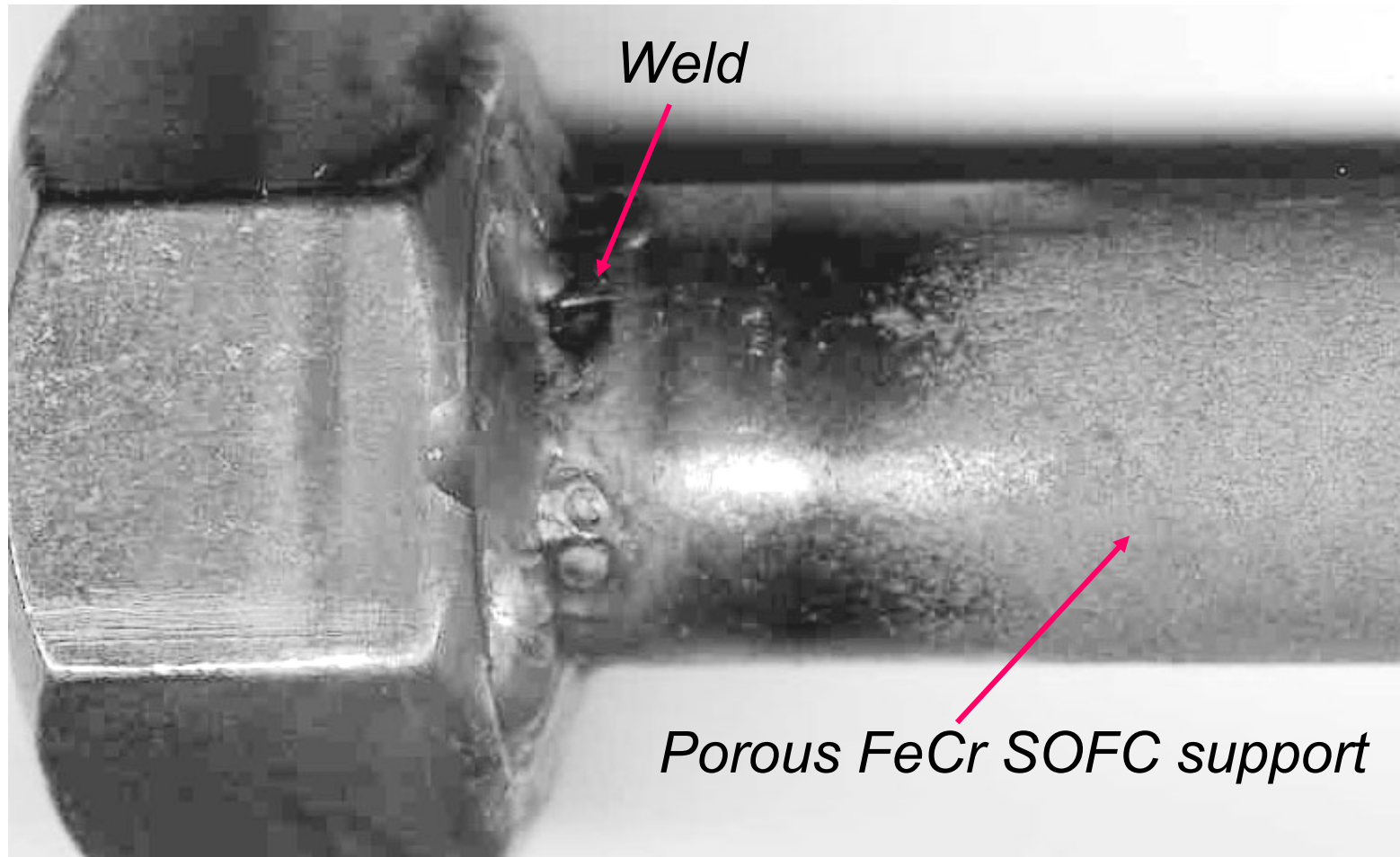

# Issues Under Investigation

- Processing of alloy/electrode/electrolyte structure
- Electrical, mechanical, and corrosion properties of porous alloy support
- Porous alloy/electrode interface stability
- Constrained sintering of dense electrolytes and porous electrodes
- Adhesion strength of porous alloy/metal and ceramic interfaces
- Stable, well bonded, high performance cathodes operating at 650-750°C
- Cathode current collector protective coating (prevent chromium evaporation)
- Sealing alloy supported cells using welding, brazing, crimping, etc.



# Proof of principle has been demonstrated

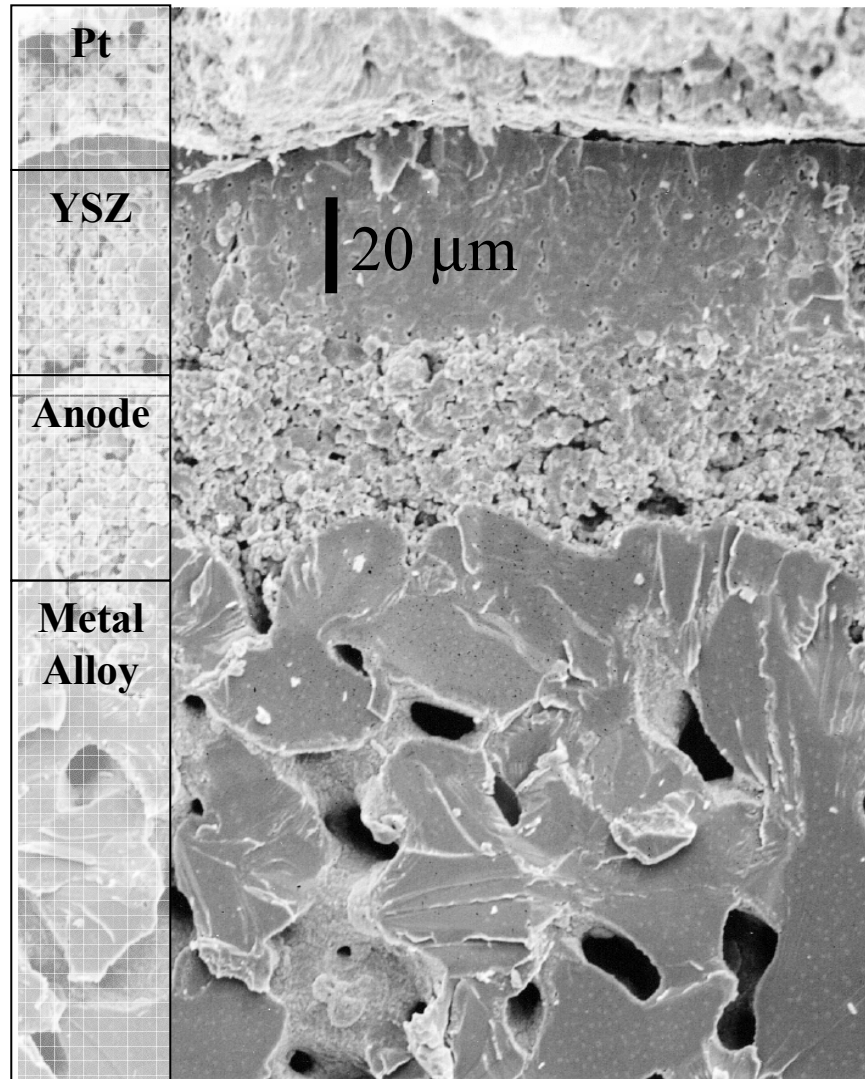

# Proof of principle has been demonstrated

Alloy Supported Thin Film Fuel Cell  
Anode:  $\text{H}_2/3\%\text{H}_2\text{O}$  Cathode: air

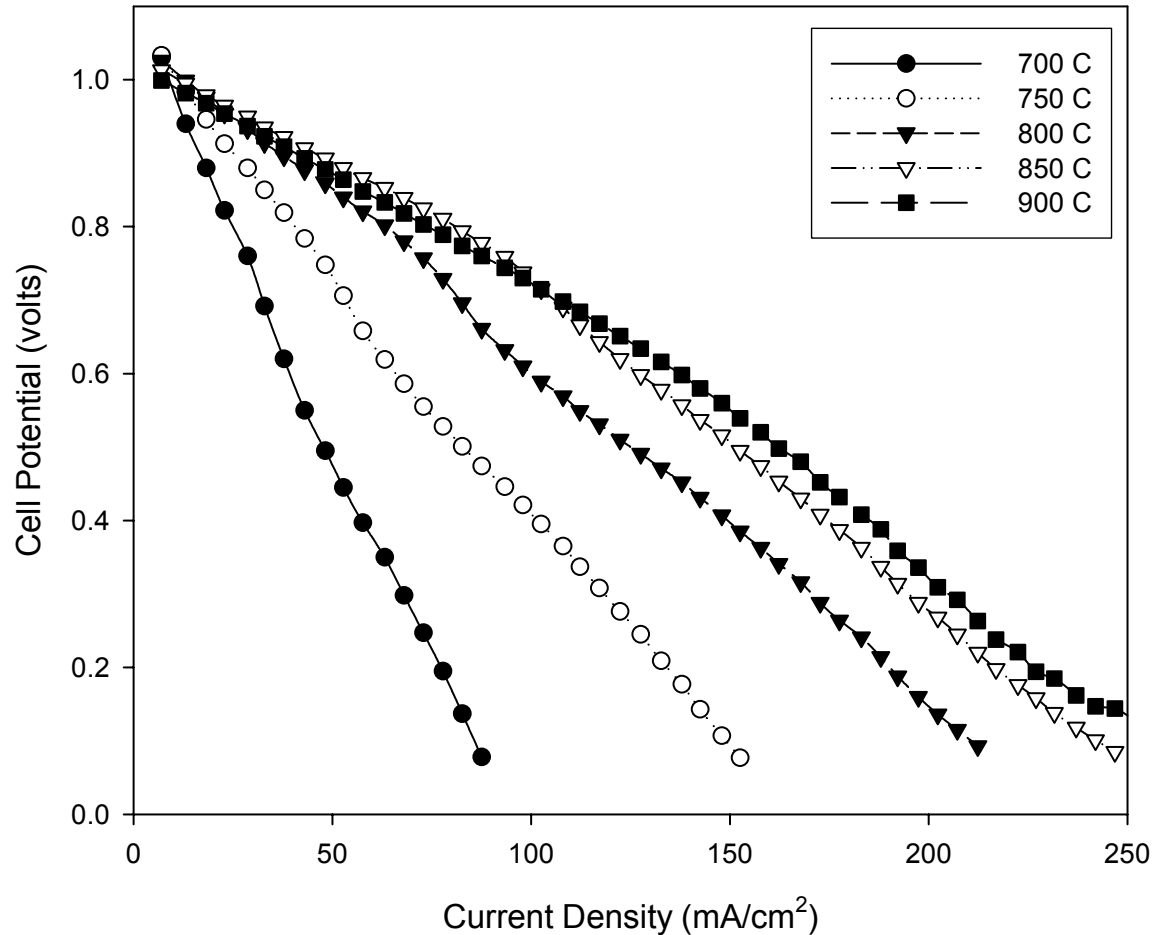

# Electrochemical Characterization of Metal-based YSZ Cells

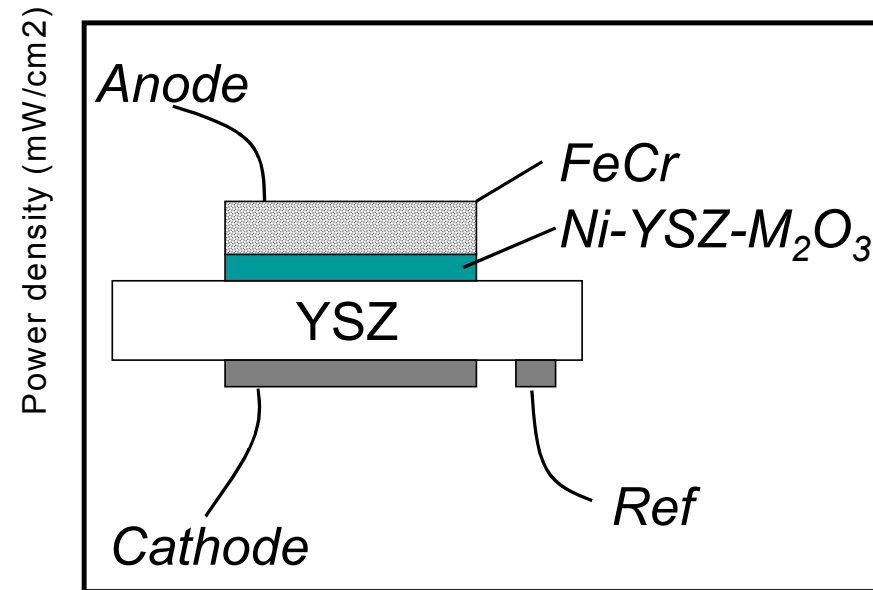
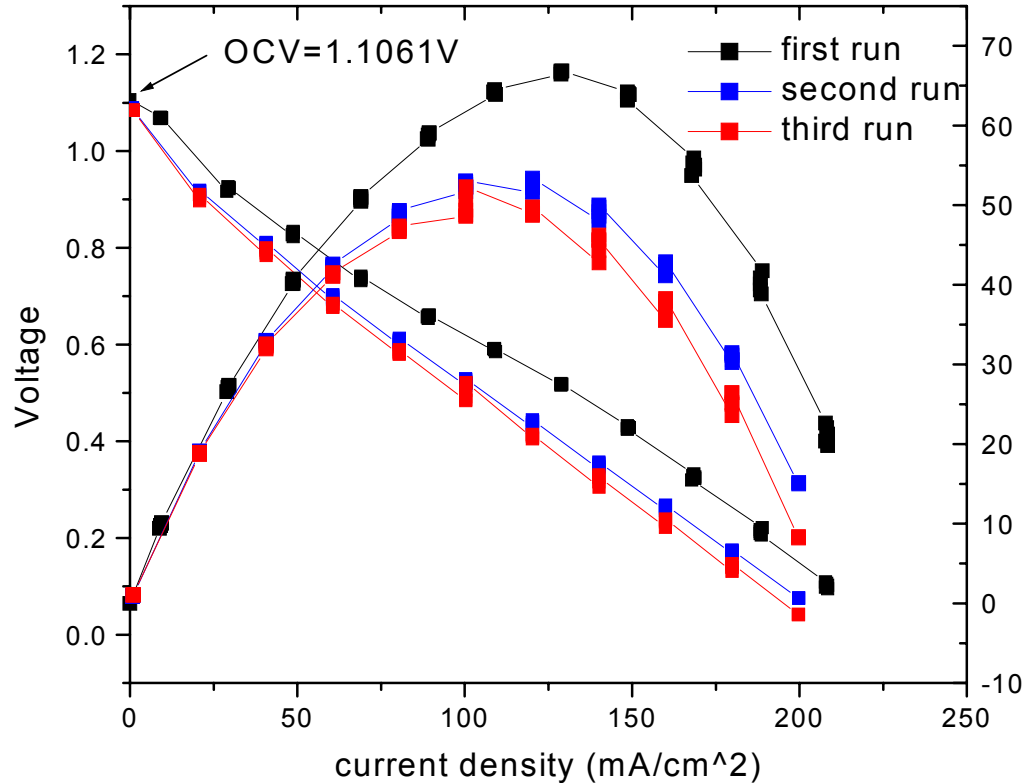

# Power Density of Metal-Based SOFCs

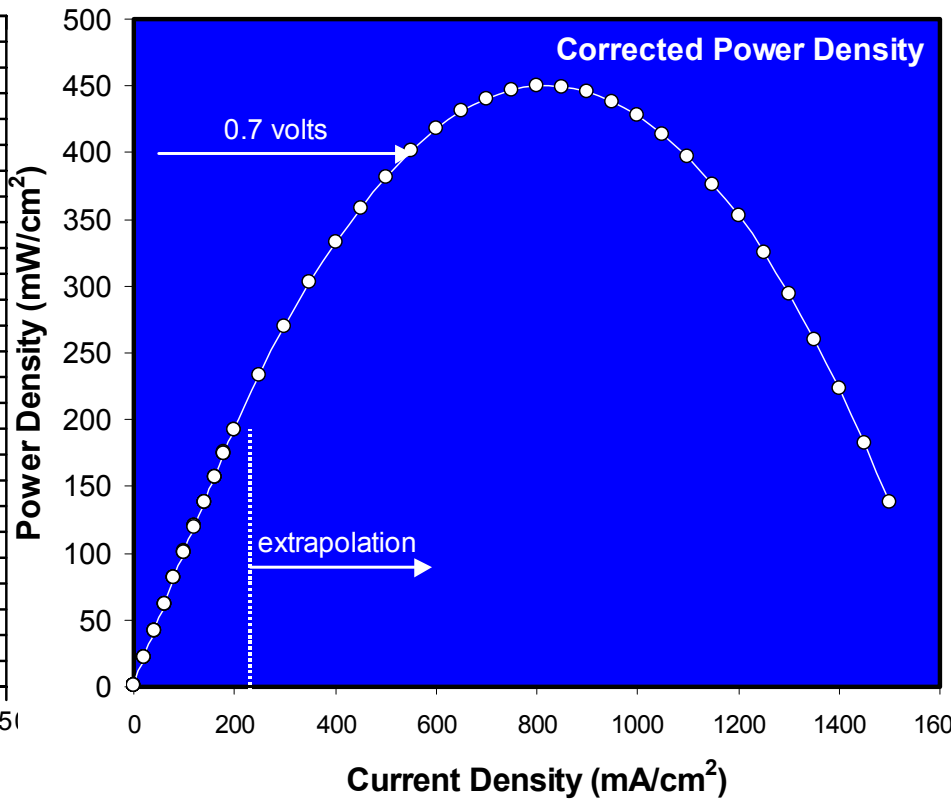
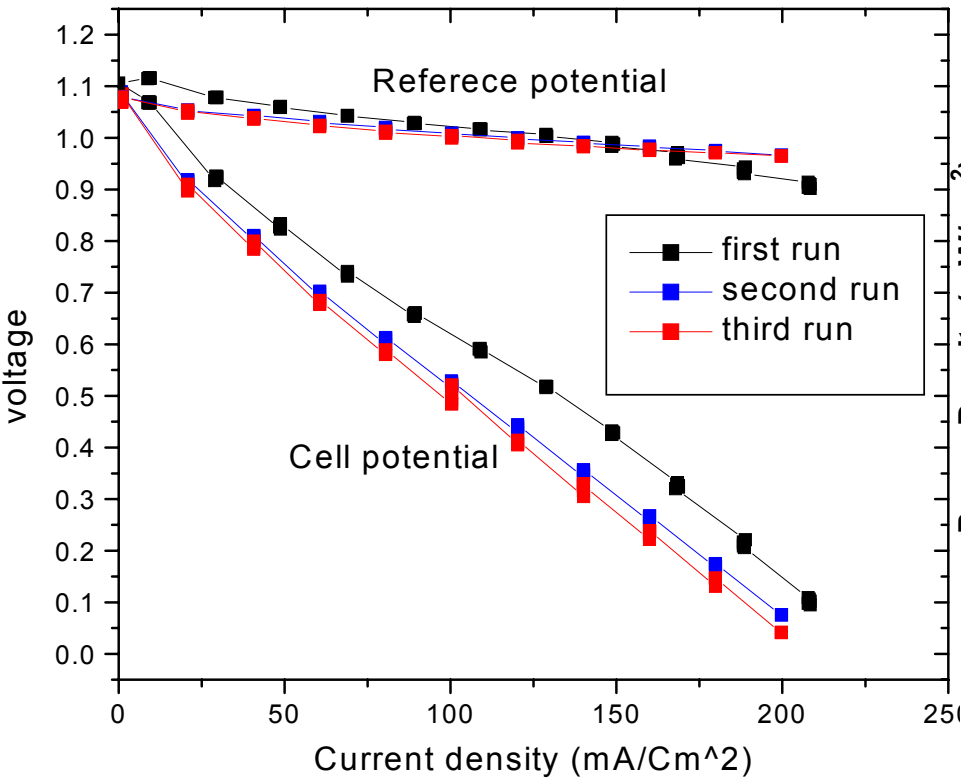

Majority of Polarization from Pt Cathode  
*(due to sintering in reducing environment)*



related work elsewhere

# The Use of Plasma-Spray to Fabricate Metal Electrode Supported SOFCs

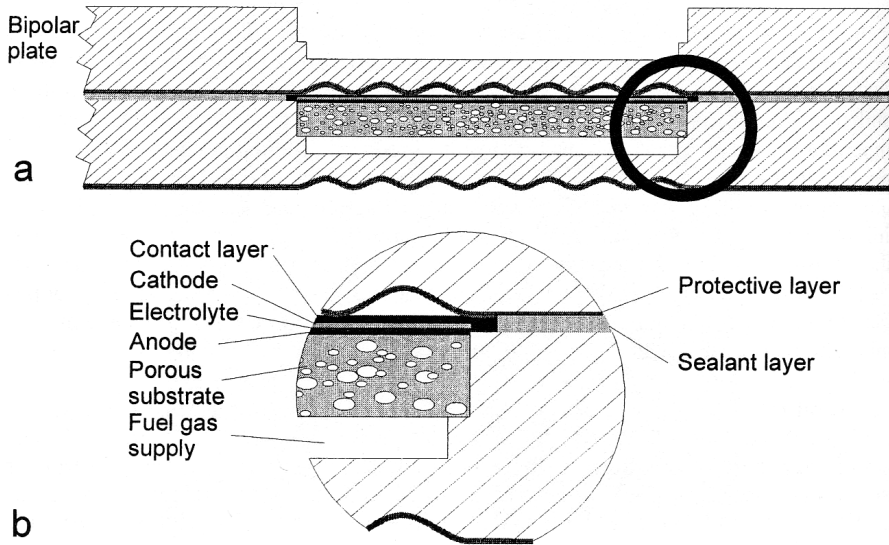

**Figure 1.** Principle of the SOFC design according to the DLR spray concept: overview (a) and detailed view (b)

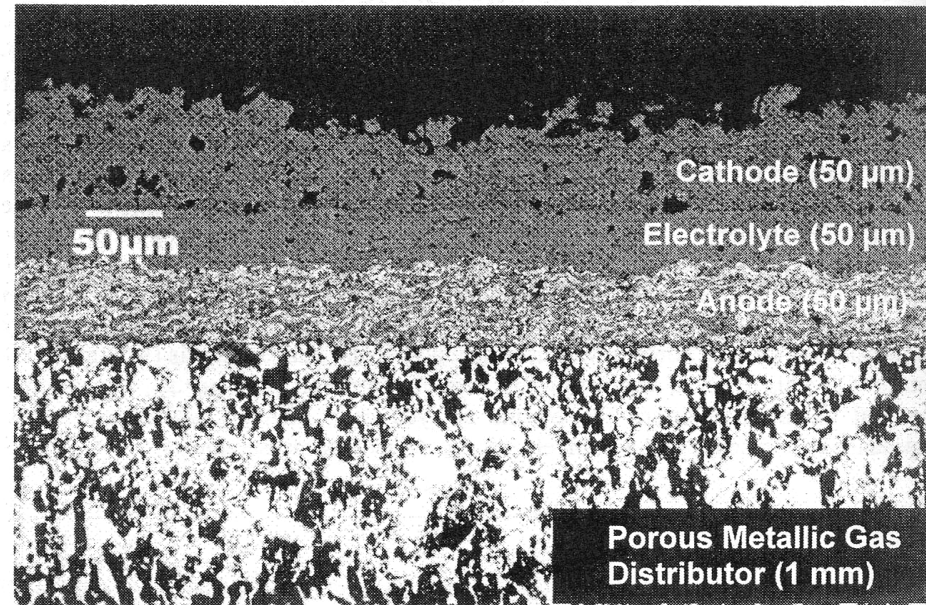

**Figure 2.** Optical micrograph of a metallographic cross-section of an entirely plasma-sprayed thin-film cell

Plasma-spray is too expensive to meet SECA cost targets

G. Schiller, R. Henne, M. Lang, S. Schager  
Deutsches Zentrum für Luft- und Raumfahrt (DLR)  
Pfaffenwaldring 38-40, D-70569 Stuttgart, Germany  
SOFC VI pg 893



# Performance of Planar Metal Supported SOFC

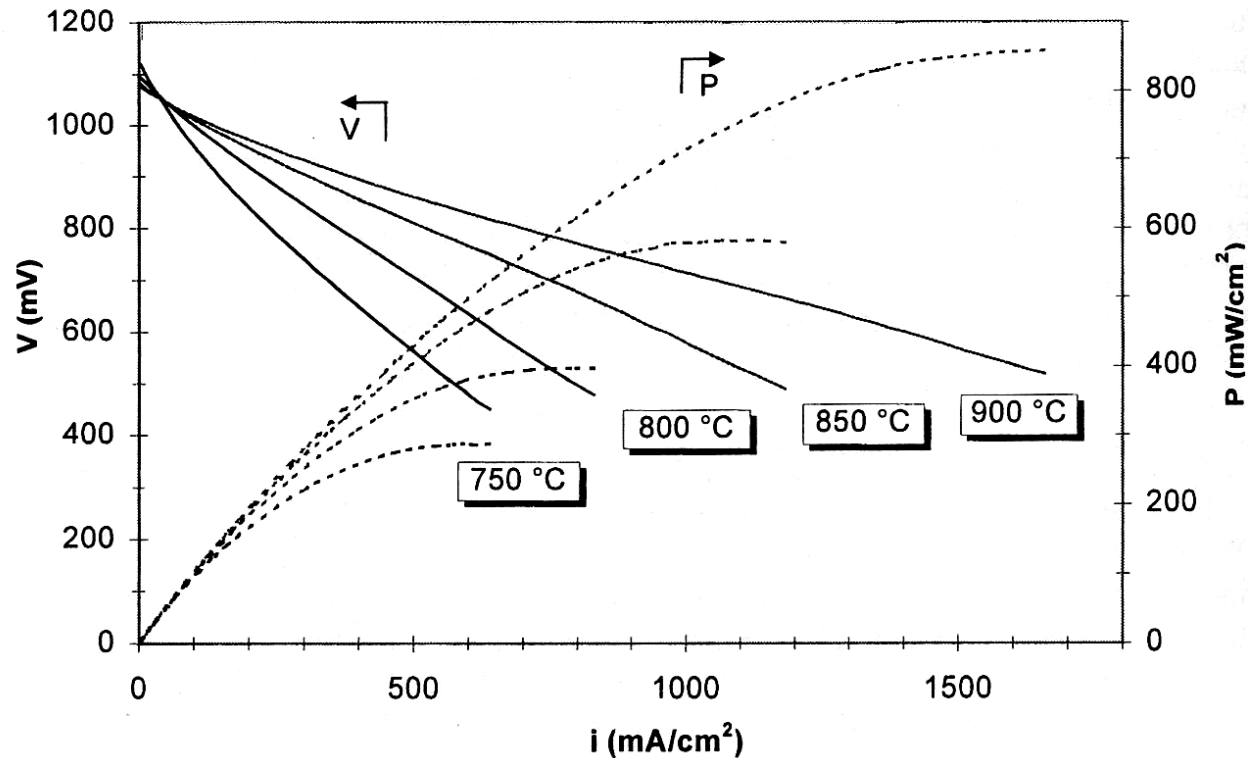
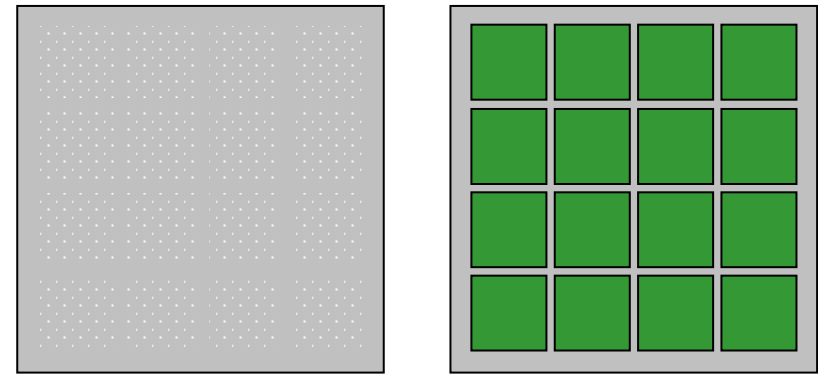
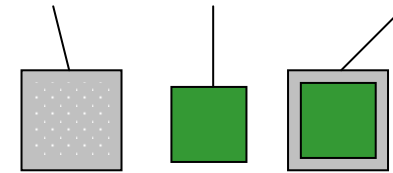

**Figure 4.** Performance of a VPS thin-film cell (YSZ/Ni anode, YSZ electrolyte, YSZ/LSM cathode) with  $\text{H}_2/\text{air}$  as the operating gases in dependence of temperature

## Metallic Supported Tile Design

Use existing thin-film cells bonded to perforated sheet

Perforated sheet    Single cell    Cell  
bonded to sheet



### Advantages of Tile Design

- Sealing
- Manufacturing small pieces
- Existing thin-film technology
- Lower tolerances required
- Lower stress per tile
- Flexible sheet formed
- Non-catastrophic failure (parallel design)
- Tailored catalyst over cell area

# Alloys for porous support and/or interconnect

- Ferritic steels with 16-26 wt% Cr are starting point.
- 430 Stainless Steel (Fe18Cr) is base alloy being investigated (steel powders with 16-30 wt% Cr of various particle sizes and type 430 and 444 sheet in hand)
- Alloys such as type 439, 441, 444, 446, 453, etc are modified with various stabilizers, reactive elements, Cr up to 26%, etc.
- Typical alloy applications: automotive exhaust manifold, heat exchanger tubing, hot water tanks, etc.
- Typical alloy properties
  - TEC  $\sim 12$  ppm/ $^{\circ}\text{C}$  to  $800^{\circ}\text{C}$
  - 7.6-7.8 g/cc
  - Thermal conductivity  $\sim 20$  W/m $\cdot$ K
  - Electronic conductivity  $\sim 12,500$  S/cm at RT and  $\sim 9,000$  S/cm at  $800^{\circ}\text{C}$
- Strength drops above  $600^{\circ}\text{C}$ , but this is not a high strength application ( $<1$  ksi!)
- Oxidation limits uncoated alloys  $\leq 800^{\circ}\text{C}$

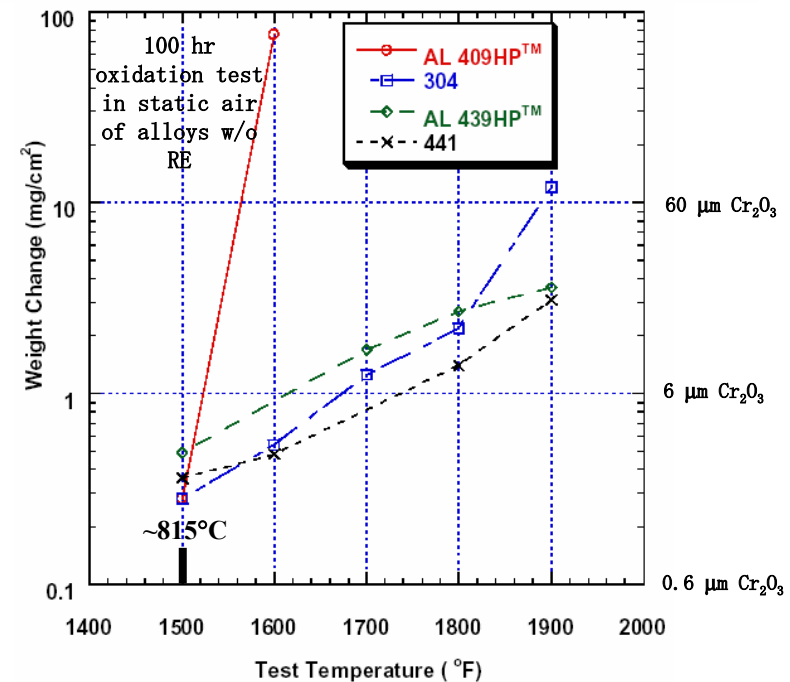
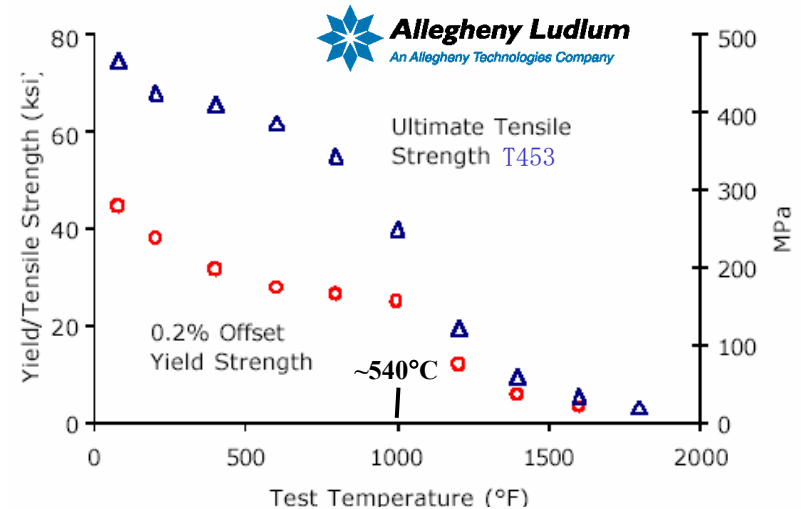

# ASR of uncoated and Y/Ni coated Ebrite

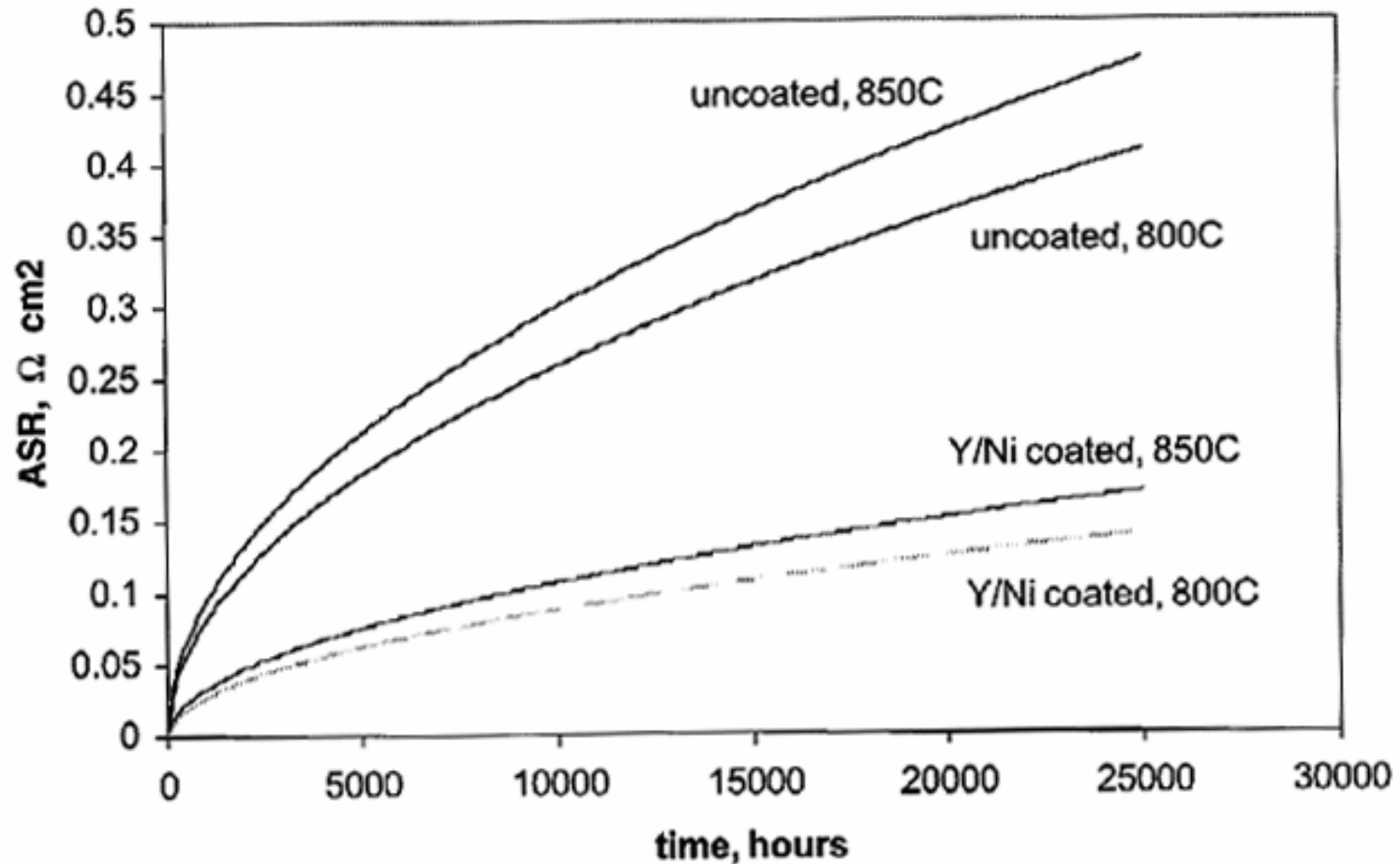

# Oxidation and possible neck failure

One concern is the failure of the porous alloy due to oxidation of the sintered necks. Is data available to guide us? Yes....

*Small necks will pinch off and lose electrical contact*

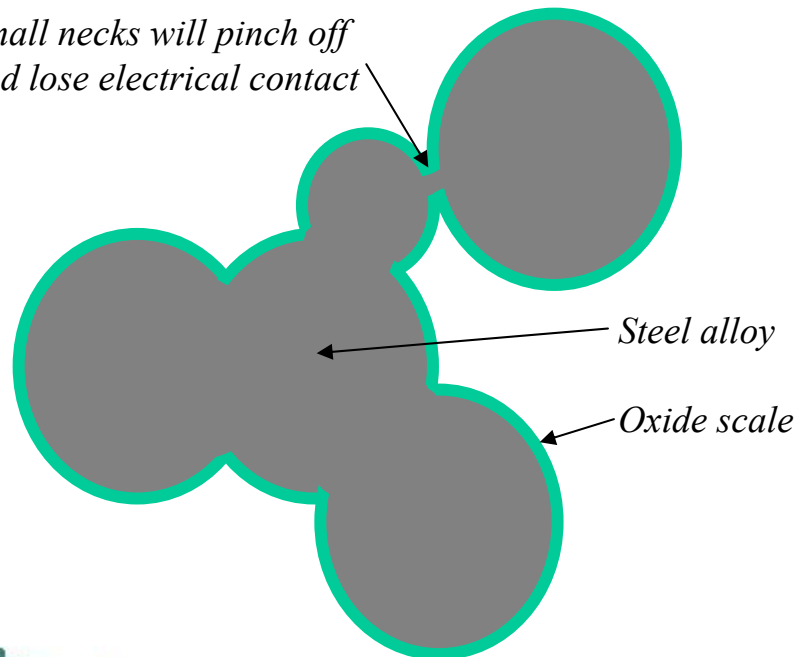

Cyclic Oxidation in Still Air

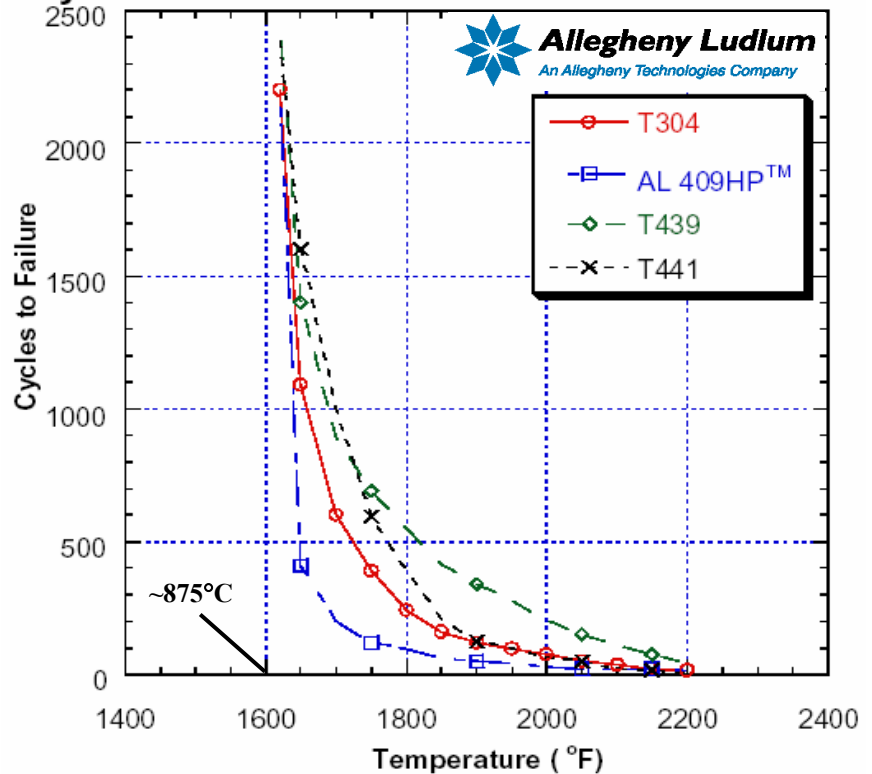

50  $\mu\text{m}$  foil is cycled between RT and test temperature in air. Failure occurs when oxidizes through and foil breaks. This type of oxidation test previously developed gives an indication Of the maximum operating temperature for a given neck size. In this case a 50  $\mu\text{m}$  neck should be stable up to ~875°C for thousands of thermal cycles.

# Corrosion of FeCr in Moist Air

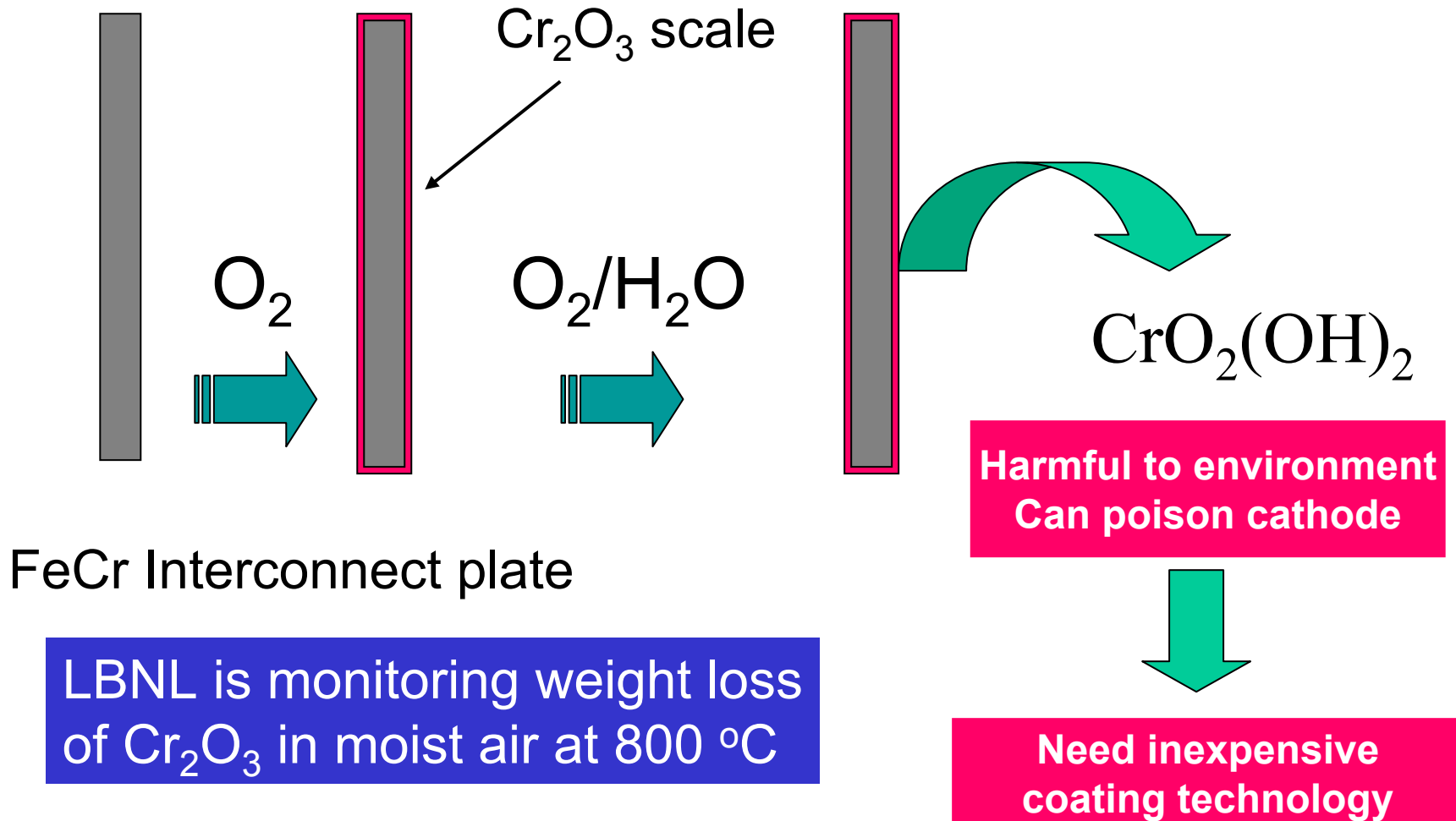

# Vapor species in equilibrium with $\text{Cr}_2\text{O}_3$ in 0.1 bar $\text{H}_2\text{O}$ , 0.1 bar $\text{O}_2$ at 1 bar total pressure

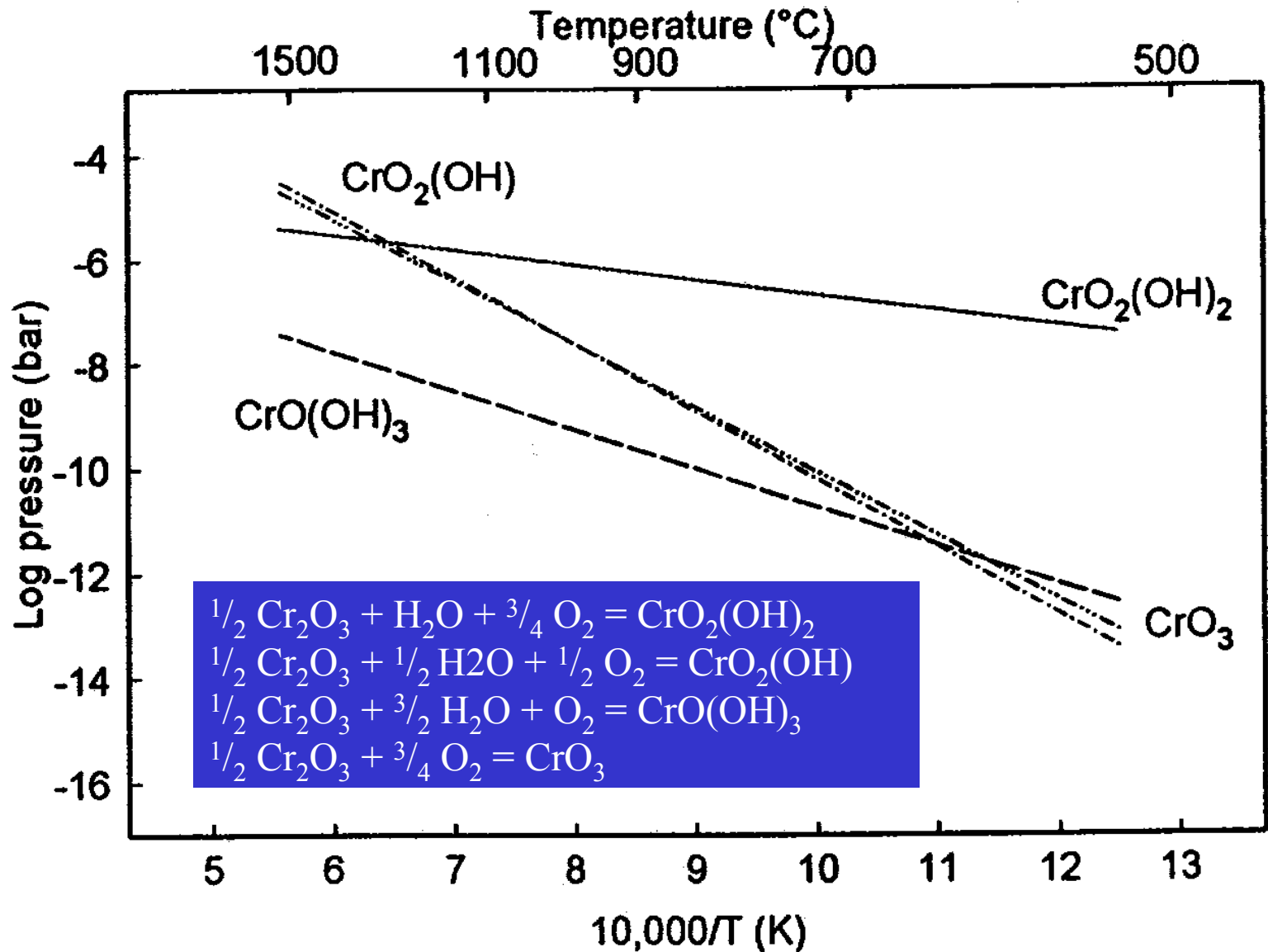



# Protective Coatings for Cathode Current Collectors

- We want to use FeCr stainless steel as current collector in SOFC with LSM cathode.
- The disadvantage is  $\text{Cr}_2\text{O}_3$  evaporation during SOFC operation.
- A dense coating with proper electrical conductivity and thermal expansion is needed to prevent  $\text{Cr}_2\text{O}_3$  evaporation.
- Possible candidates are doped chromite or Cr-based spinels



# Spinel coatings at the interface of LSM cathode and FeCr current collector

Mn-Cr-O, Mn-Co-Cr-O, Co-Cr-O, Mn-Co-O spinel are promising coating materials for FeCr current collector. Two goals should be reached.

- 1) A dense layer of spinel should be formed between FeCr and LSM to block the evaporated Cr oxide to diffuse into LSM.
- 2) The spinel layer should have enough conductivity at least bigger than usual coating materials such as La-Cr-O.



446 SS Alloy

Chromia scale (dark grey)

Mn-Cr-O spinel particles (angular)

Porous LSM layer

LSM green power sintered on dense FeCr stainless steel at 1200°C/4h in air results in porous MnCr spinel layer. Chromium oxyhydroxide evaporation is not prevented.

# LSM Cathode and FeCr Interfacial Reactions

LSM reacts with the alloy to produce a *porous* spinel coating

---

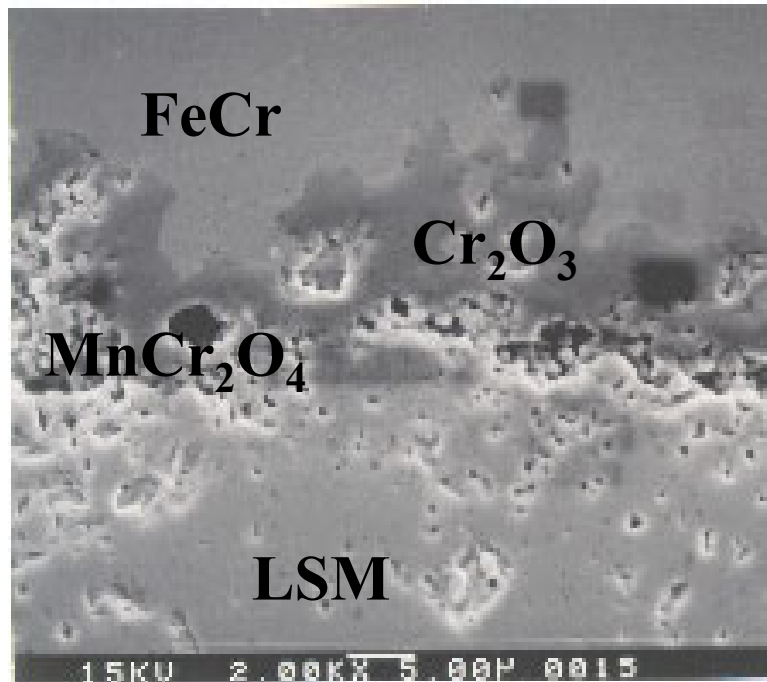

LSM green power with fully dense FeCr stainless steel sintered at 1200°C/4h in air

EDS shows a porous layer of  $\text{MnCr}_2\text{O}_4$  spinel formed at the interface, this is insufficient for preventing chromium evaporation...

Can this spinel be made dense to prevent  $\text{Cr}_2\text{O}_3$  from evaporating?

Does the spinel have enough electronic conductivity?

Does the thermal expansion of the spinel match that of the cathode?

This work will determine the suitability of various spinels for this application and then seek means of creating dense layers on FeCr alloys



**One approach is to obtain a dense coating of the desired spinel**

---

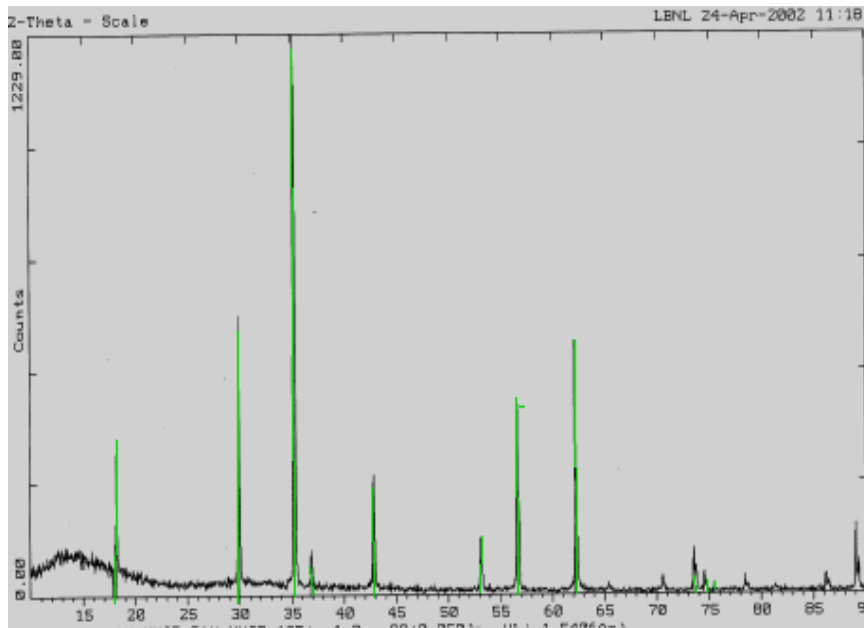

**X-ray of MnCr<sub>2</sub>O<sub>4</sub> spinel made by GNP synthesis. This powder is then applied to the alloys surface and sintered.**

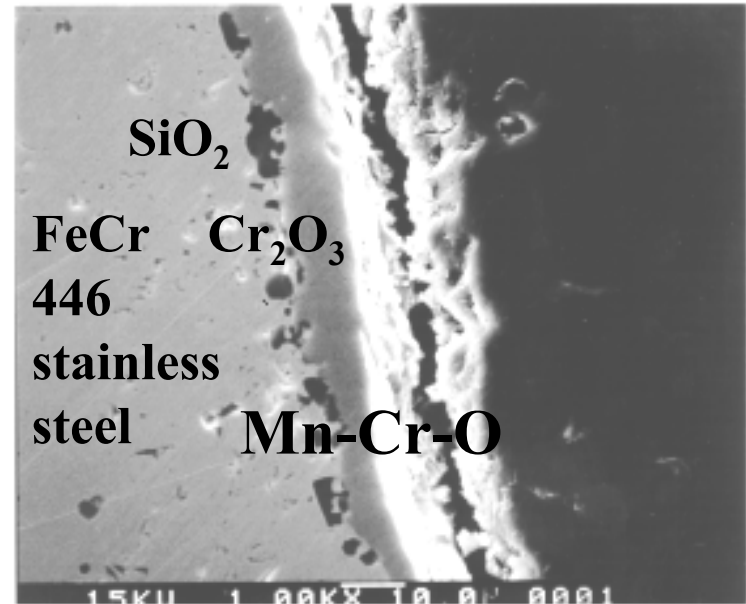

**SEM of MnCr<sub>2</sub>O<sub>4</sub> and FeCr interface sintered at 1200°C/4h in air**



**A second approach is to deposit a continuous Mn-oxide layer and grow a continuous layer of the desired spinel.**

---

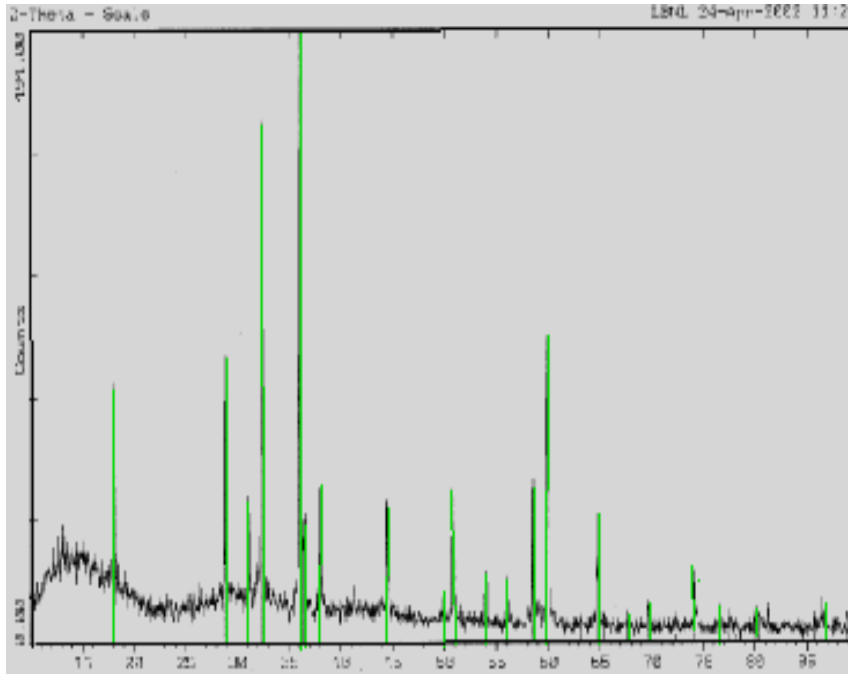

**X-ray of Mn<sub>3</sub>O<sub>4</sub> powder**

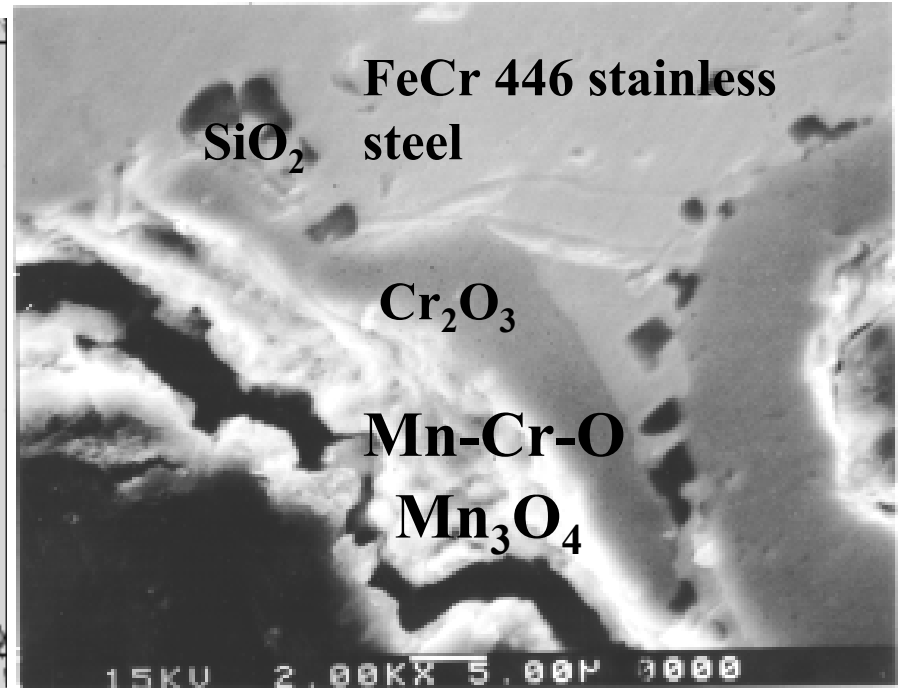

**SEM of Mn<sub>3</sub>O<sub>4</sub> and FeCr interface sintered at 1200°C/4h in air**



## Protective Coating Future Work

- **Measure the electrical conductivity and thermal expansion of  $\text{MnCr}_2\text{O}_4$  spinel**
- **Test whether this  $\text{MnCr}_2\text{O}_4$  spinel layer is effective in preventing Cr evaporation**
- **Develop a low-cost, effective method of creating the  $\text{MnCr}_2\text{O}_4$  on FeCr current collectors**



# NETL Cathode Studies

**Purpose:** *Stable, high performance cathodes for operation between 650-750°C*

**Basic Problem:** *High performance cathodes involve unstable microstructures and/or chemical and thermal expansion incompatibility with YSZ*

- Preparation of YSZ thick electrolyte discs with controlled surface
- Basic electrochemical studies using Ag, Pt, Pd-Ag, and Au as electrodes
- Study the effect of bulk and surface additives on the electrochemical performance of LSM and LSM + YSZ on YSZ symmetric cell
- Preparation of LSM + YSZ electrodes with and without bulk additives such as: LSCF, CGO, and  $\text{Co}_2\text{O}_3$
- Preparation of LSM electrodes with and without surface additives such as  $\text{CoO}/\text{Co}_2\text{O}_3$

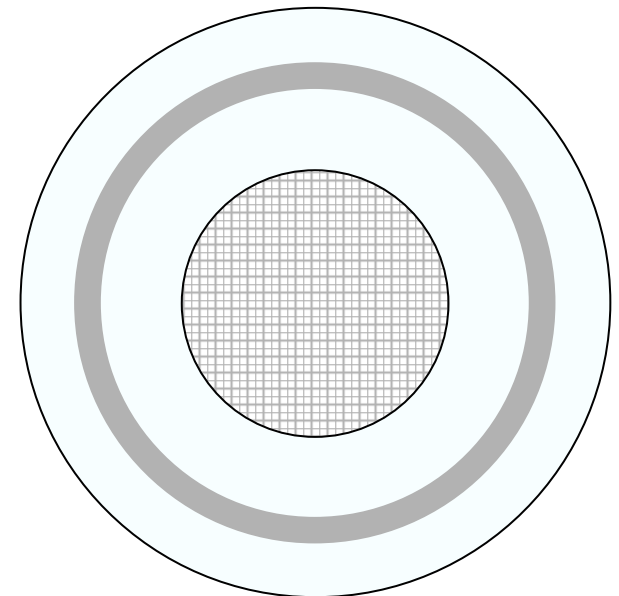
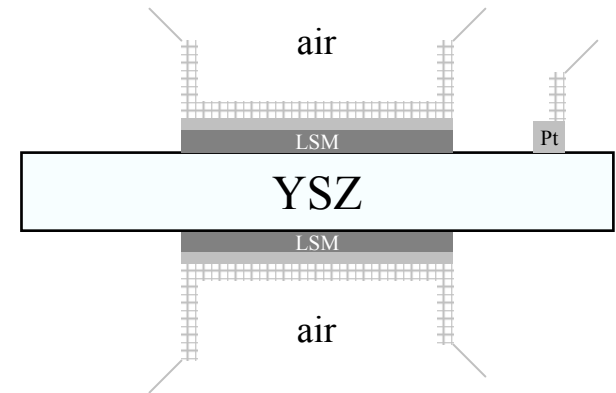

# Surface Doped Electrode Fabrication

- 1) Die press YSZ disk
- 2) Sinter disk at 1500°C
- 3) Polish disk (30 μm)
- 4) Spray cathodes
- 5) Sinter cathodes at 1200°C
- 6) Attach platinum current collectors and reference
- 7) Fire at 950°C
- 8) Dope cathodes with cobalt solution
- 9) Fire at 600°C

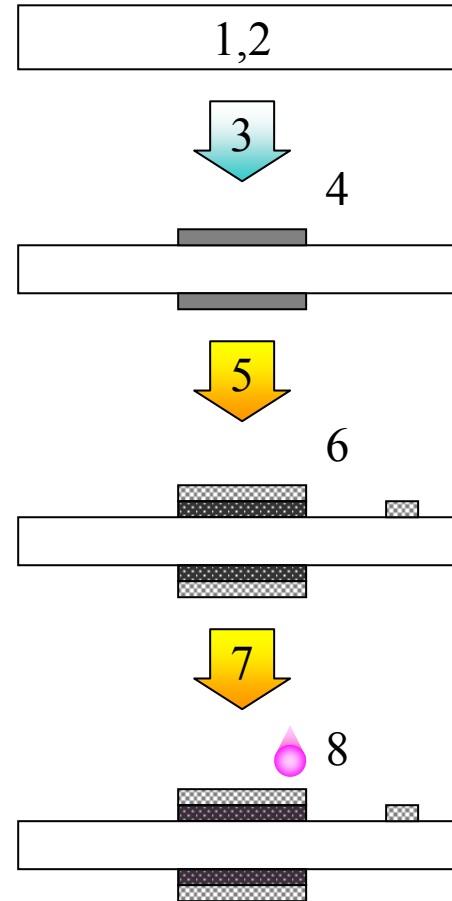

Related prior art:

ELECTRODE STRUCTURE FOR SOLID STATE ELECTROCHEMICAL DEVICES,  
U.S. Pat. No. 5,670,270. Dow Chemical Company



# Proposed O<sub>2</sub> Reaction Mechanism

- Highlights
  - O<sub>2</sub> surface diffusion to active site
  - Charge transfer
  - O<sup>=</sup> diffusion through LSM to YSZ
- Cobalt increases ionic conductivity and  $\delta$
- Critical question: *Is this strictly a surface effect or does the Co diffuse into the bulk and alter the LSM composition?* This has implication for long-term stability of these doped electrodes.

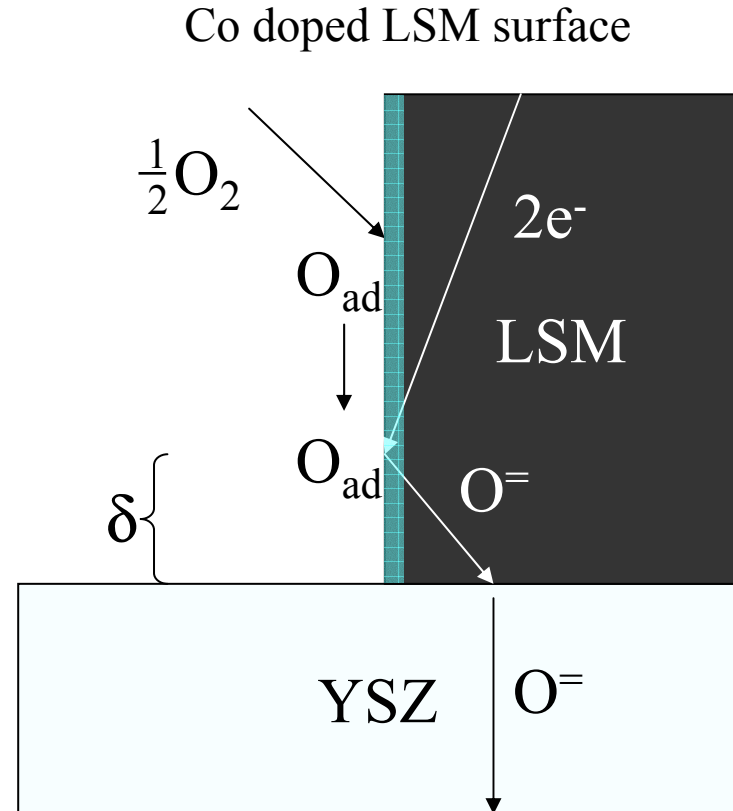

# NETL Projects April-June 2002

## Scale-up and automate process

1. Tape casting of metal supports
2. Automated screen printing of electrodes
3. Automated spray deposition of electrodes and electrolytes

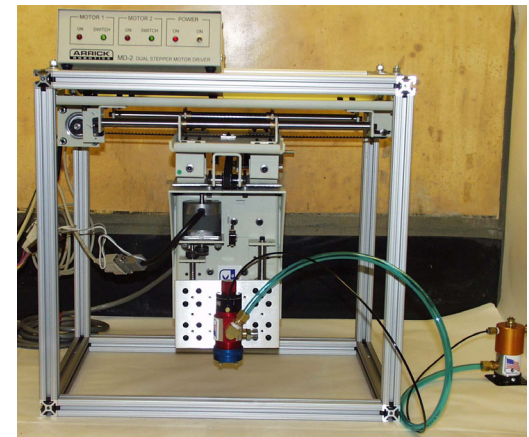
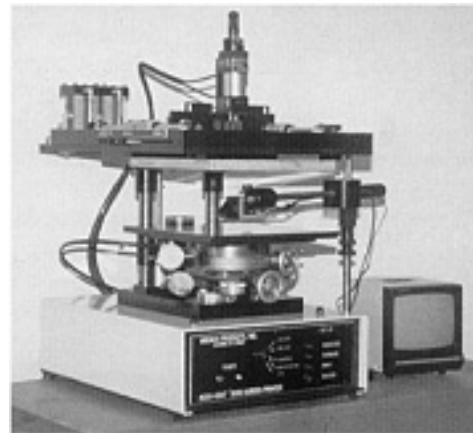

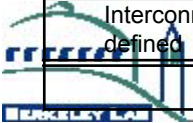
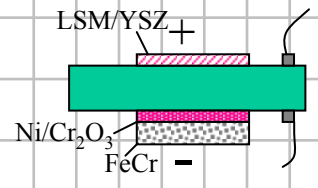
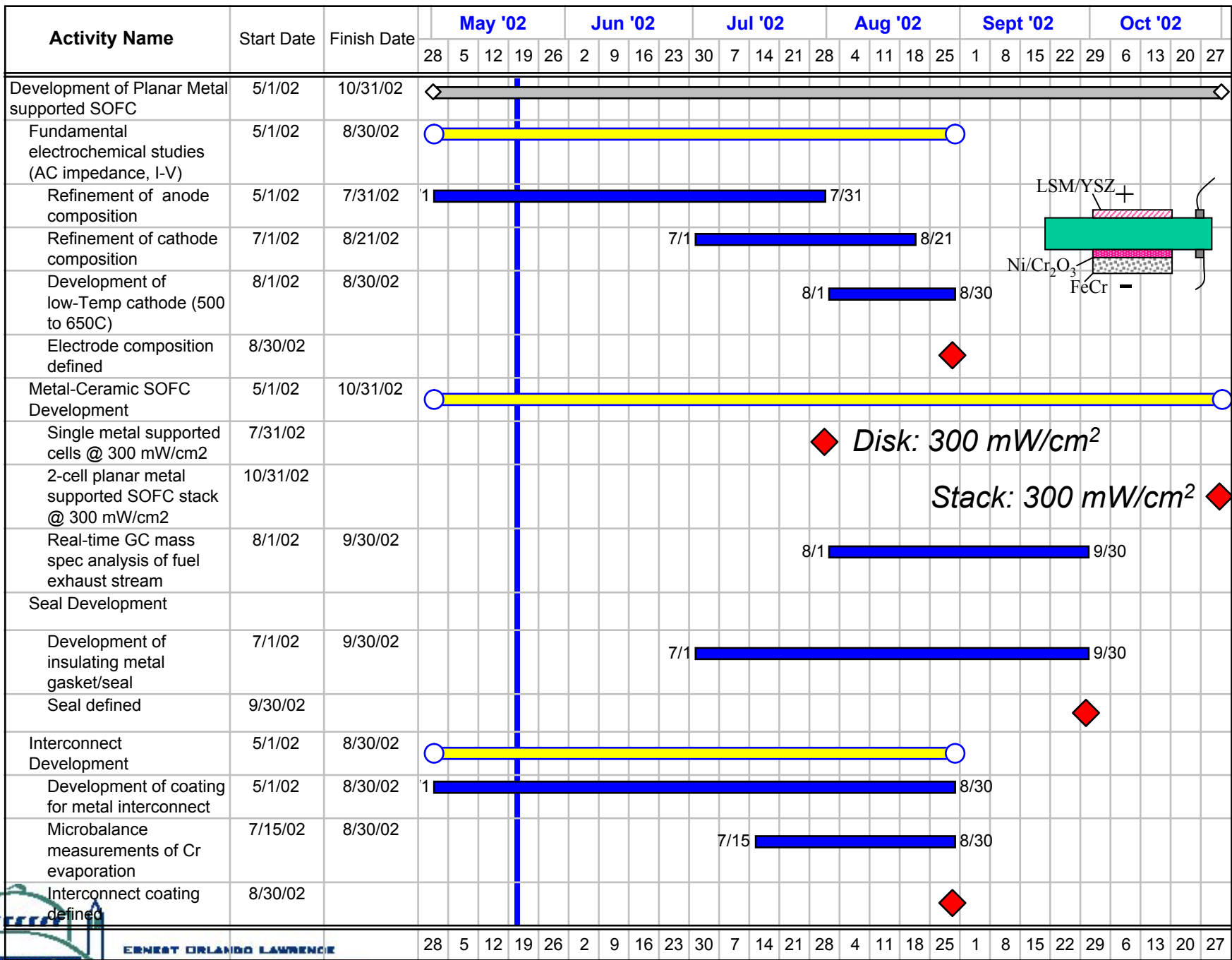

# Summary

- Proof of principle: low-cost alloy support architecture effective
- Support-plate concept: Ni-YSZ , LSM, and alloy bonding demonstrated
- Evaluation of cathode-interconnect interface initiated: conductive spinel interlayer expected to be effective
- Development of stable, high performance cathode for 650-750°C operation
- Invention disclosure:  
IB-1790: Support for planar fuel cells



# Future work

- Improve low-cost alloy support architecture
- Support-plate concept: integrate in functioning fuel cell
- Continued development of cathode-interconnect interface
- Continued development of intermediate temperature cathodes
- Constrained sintering of electrolyte film on metallic support electrode structure

